

ACTA
SILVATICA
&
LIGNARIA
HUNGARICA

AN INTERNATIONAL JOURNAL
IN FOREST, WOOD
AND ENVIRONMENTAL
SCIENCES

VOLUME 1
2005

ACTA SILVATICA
&
LIGNARIA
HUNGARICA

ACTA
SILVATICA
&
LIGNARIA
HUNGARICA

AN INTERNATIONAL JOURNAL
IN FOREST, WOOD
AND ENVIRONMENTAL
SCIENCES

VOLUME 1
2005

ACTA SILVATICA ET LIGNARIA HUNGARICA

AN INTERNATIONAL JOURNAL

IN FOREST, WOOD AND ENVIRONMENTAL SCIENCES

issued by the Forestry Commission of the Hungarian Academy of Sciences

Acta Silvatica et Lignaria Hungarica (ASLH) publishes original reports and reviews in the field of forest, wood and environmental sciences in English or German language.

ASLH is published in serial volumes

The journal is financially supported by the

Hungarian Academy of Sciences (HAS),

Faculty of Forestry, University of West Hungary (FF-UWH),

Faculty of Wood Sciences, University of West Hungary (FWS-UWH),

Hungarian Forest Research Institute (HFRI).

Institute of Wildlife Management, University of West Hungary (IWM-UWH),

Editor-in-Chief:

CSABA MÁTYÁS (FF-UWH SOPRON)

Editorial Board:

LÁSZLÓ BEJÓ (FWS-UWH SOPRON),

NORBERT FRANK (FF-UWH SOPRON),

ZOLTÁN SOMOGYI (HFRI BUDAPEST)

Managing editor:

MAGDOLNA STARK (FF-UWH SOPRON)

Scientific Committee:

President:

REZSŐ SOLYMOS (HAS BUDAPEST)

Members:

SÁNDOR FARAGÓ (FF-UWH SOPRON),

ERNŐ FÜHRER (HFRI BUDAPEST),

KÁROLY MÉSZÁROS (FF-UWH SOPRON),

SÁNDOR MOLNÁR (FWS-UWH SOPRON),

ANDRÁS WINKLER (FWS-UWH SOPRON)

HU ISSN 1786-691X

Manuscripts and editorial correspondence should be addressed to

MAGDOLNA STARK, ASLH EDITORIAL OFFICE

UNIVERSITY OF WEST HUNGARY,

PF. 132, H-9401 SOPRON, HUNGARY

Phone: +36 99 518 122

Fax: +36 99 329 911

E-mail: ASLH@NYME.HU

Information and electronic edition: [HTTP://ASLH.NYME.HU](http://ASLH.NYME.HU)

Cover design by ANDREA KLAUSZ

Printed by LŐVÉR PRINT KFT., SOPRON

Contents

PREFACE	7
BARTHA, Dénes – KIRÁLY, Gergely – VIDÉKI, Róbert – NAGY, Anikó: Occurrence of Rare Tree and Shrub Species in Hungary	9
MIHÓK, Barbara – GÁLHIDY, László – KELEMEN, Kristóf – STANDOVÁR Tibor: Study of Gap-phase Regeneration in a Managed Beech Forest: Relations between Tree Regeneration and Light, Substrate Features and Cover of Ground Vegetation	25
HÖHN, Mária – ÁBRÁN, Péter – VENDRAMIN, Giovanni Giuseppe: Genetic Analysis of Swiss Stone Pine Populations (<i>Pinus cembra</i> L. subsp. <i>cembra</i>) from the Carpathians Using Chloroplast Microsatellites	39
WINKLER, Dániel: Ecological Succession of Breeding Bird Communities in Deciduous and Coniferous Forests in the Sopron Mountains, Hungary	49
CSÓKA, György – SZABÓKY, Csaba: Checklist of Herbivorous Insects of Native and Exotic Oaks in Hungary I.	59
KOPPÁN, András – SZARKA, László – WESZTERGOM, Viktor: Local Variability of Electric Potential Differences on the Trunk of <i>Quercus cerris</i> L. ..	73
BARTA, Edit – PAPP, György – PREKLET, Edina – TOLVAJ, László – BERKESI, Ottó – NAGY, Tamás – SZATMÁRI, Sándor: Changes in the DRIFT Spectra of Softwood Materials Irradiated by UV-laser as a Function of Energy	83
SZALAI, József: Technische Festigkeiten der 'Pannonia' Pappel (<i>Populus x euramericana</i> cv. Pannonia) und der Zerreiche (<i>Quercus cerris</i> L.)	93
DIVÓS, Ferenc – TANAKA, Toshinari: Relation between Static and Dynamic Modulus of Elasticity of Wood	105
BEJÓ, László – TAKÁTS, Péter – VASS, Norbert: Preliminary Experiences with Cement Bonded Composite Beams	111

Tartalomjegyzék

ELŐSZÓ	7
BARTHA Dénes – KIRÁLY Gergely – VIDÉKI Róbert – NAGY Anikó:	
Ritka fa- és cserjefajok magyarországi előfordulása	9
MIHÓK Barbara – GÁLHIDY László – KELEMEN Kristóf – STANDOVÁR Tibor:	
A fás újulat vizsgálata kezelt bükkös erdő lékjeiben: az újulat valamint a fény, a talajfelszíni jellemzők és az aljnövényzeti borítás összefüggései	25
HÖHN Mária – ÁBRÁN Péter – VENDRAMIN, Giovanni Giuseppe:	
Genetikai diverzitás vizsgálatok a Kárpátok cirbolyafenyő (<i>Pinus cembra</i> L. subsp. <i>cembra</i>) populációiban kloroplasztisz mikroszatellit markerek felhasználásával	39
WINKLER Dániel:	
Fészkelő madárközösségek szukcessziójának vizsgálata a Soproni-hegység lomb- és fenyő állományaiiban	49
CSÓKA György – SZABÓKY Csaba:	
A magyarországi tölgyek herbivor rovarainak listája I.	59
KOPPÁN András – SZARKA László – WESZTERGOM Viktor:	
Elektromos potenciálkülönbségek lokális változása <i>Quercus cerris</i> L. törzsén	73
BARTA Edit – PAPP György – PREKLET Edina – TOLVAJ László – BERKESI Ottó – NAGY Tamás – SZATMÁRI Sándor:	
UV-lézerrel besugárzott fenyő faanyag DRIFT spektrumának változása az energia függvényében	83
SZALAI József:	
A pannónia nyár (<i>Populus x euramericana</i> cv. Pannonia) és a csertölgy (<i>Quercus cerris</i> L.) technikai szilárdságai	93
DIVÓS Ferenc – TANAKA Toshinari:	
Kapcsolat a faanyag statikus és dinamikus rugalmassági modulusza között	105
BEJÓ László – TAKÁTS Péter – VASS Norbert:	
A cement-kötésű kompozit gerendák kifejlesztésének kezdeti lépései	111

Preface

A START FOR ACTA SILVATICA

It has been a long-nourished demand of Hungarian researchers in forestry and wood sciences to publish an independent foreign-language (English, German) journal in order to enhance international contacts.

Scientific research began when higher education in forestry started in 1808. After WWI the majority of the country's forests have fallen to neighbouring countries leaving a forest cover of 1.1 million ha out of the former 7.3 million hectares. For a country poor in forests, importing timber was a heavy burden. To increase forest area and wood yield was the primary objective of the foresters. Research tasks have been selected accordingly.

After WWII the Forest Research Institute was re-established in 1949 in Budapest. Up to the late 1960s the scope of research topics kept increasing from genetics to mechanization. Wood sciences developed in a similar way. A series of research achievements were applied in practice. As a result forest area of the country has grown by 600 thousand ha until the Millennium, while wood yield of the forests doubled.

In the second half of the 20th century, ecological thinking started spreading in forestry, to sustain and restore biodiversity of the forest. Research topics centred around close-to-nature silviculture and complete utilization of harvested wood. Forestry management of the 20th century promotes the multiple use of forests and the improved use of harvested timber. The nature protection and recreation role of the forests kept advancing. Present research focuses on comprehensive treatment of forestry and wood sciences within the complexity of ecosystems. Advanced processing of environmentally friendly wood has won priority. Research in wildlife management is also worth mentioning here. Hungary's wildlife research has achieved international recognition, as the country has a wide range of small and big game research programs.

The Forest Research Institute in Budapest, and the Faculties of Forestry and of Wood Sciences at the University of West Hungary in Sopron are engaged in forestry, wildlife management and wood sciences research. Extension research work is carried out also by the State Forest Service and by the National Institute for Agricultural Quality Control

*As an EU member, Hungary is striving for a better involvement in international cooperation. Utilisation of the natural, mixed forests as well as of the plantations of the naturalised black locust offer promising research topics. Looking forward to achieve mutual benefits, the Forestry Committee of the Hungarian Academy of Sciences, the Forest Research Institute and the Forestry and Wood Sciences Faculties of the University of West Hungary launch the journal *Acta Silvatica et Lignaria Hungarica*.*

*Rezső Solymos
member of Hung. Ac. Sci.
head of Scientific Committee*

E l ő s z ó

ÚTJÁRA INDUL AZ ACTA SILVATICA ...

Az erdészet- és fatudomány magyarországi művelőinek régi törekvése, kívánsága teljesül azzal, hogy egy több nyelvű (angol, német) kiadvány útján is bővítsék nemzetközi kapcsolataikat.

A kutatás kezdetei már az 1808-ban létrehozott erdészeti felsőoktatással esnek egybe. Az első világháborút követően az ország erdeinek jelentősebb részét a szomszédos államokhoz csatolták, 7,3 millió ha erdőből csak 1,1 millió ha maradt. Az erdőben és fában szegény országnak súlyos terhet okozott a faimport. Az erdészet fő feladata az erdőterület és az erdők fahozamának növelése volt. Ennek megfelelően választották ki a legfontosabb kutatási témákat.

A második világháború után 1949-ben Budapesten újraalapították az Erdészeti Tudományos Intézetet, amelynek keretében a 60-as évek végéig kiteljesedett a kutatási témák teljes köre a genetikától a gépesítésig. Hasonló volt a helyzet a faipari kutatások területén is. A kutatási eredmények sorát hasznosította az erdészeti és a faipari gyakorlat. Ennek is köszönhető, hogy az ország erdőterülete az ezredfordulóig mintegy 600 ezer ha-ral bővült, erdeinek fakészlete pedig a kétszeresére emelkedett.

A XX. század második felében egyre nagyobb tért hódított az ökológiai szemléletű erdőgazdálkodás, az erdők biodiverzitásának fenntartása és helyreállítása. A kutatási témák főleg a természet közeli erdőgazdálkodás, valamint a megtermelt fa teljes felhasználásával kapcsolatos témacsoportból kerültek ki. A XX. század magyarországi erdőgazdálkodása és a fagazdaságot a multifunkcionalitás, az erdők sokoldalú hasznosítására való törekvés valamint a fahasznosítás bővítése jellemzi. A természetvédelem, az erdő jóléti szerepe került az első helyre. Az élővilág egészébe illesztve, a kölcsönhatások figyelembevételével folyik jelenleg az erdészeti és faipari kutatás. A környezetbarát fa magas színvonalú feldolgozása elsőrendű feladat. Itt kell még megemlékezni a vadgazdálkodási kutatásokról is. Magyarország vadállománya nemzetközileg elismert. Széleskörű apró- és nagyvad gazdálkodási kutatás folyik.

Magyarországon az erdő- vad és fatudományi kutatások jelenleg az Erdészeti Tudományos Intézetben, valamint a Nyugat-Magyarországi Egyetem Erdőmérnöki és Faipari Mérnöki Karain folynak. Jelentős kutató-fejlesztő munkát végez az Állami Erdészeti Szolgálat és az Országos Mezőgazdasági Minősítő Intézet is.

EU tagként azt reméljük, hogy az eddigieknél is jobban bekapcsolódhatunk a nemzetközi együttműködésbe. Hasznos kutatási lehetőségeket ígérnek a magyarországi őshonos fafajú elegyes erdők és a speciálisan magyarnak tartott fának, az akácnak a hasznosítása. A kölcsönös előnyök reményében ezekkel a gondolatokkal indítja útjára a Magyar Tudományos Akadémia Erdészeti Bizottsága az Erdészeti Tudományos Intézet és a Nyugat-Magyarországi Egyetem Erdőmérnöki valamint Faipari Mérnöki Karainak támogatásával az „Acta Silvatica et Lignaria Hungarica” folyóiratot.

*Solymos Rezső
akadémikus
Szerkesztő Bizottság elnöke*

Occurrence of Rare Tree and Shrub Species in Hungary

Dénes BARTHA* – Gergely KIRÁLY – Róbert VIDÉKI – Anikó NAGY

Department of Botany, Faculty of Forestry, University of West Hungary, Sopron, Hungary

Abstract – The Department of Botany has been focusing on investigating rare taxa of the Hungarian dendroflora since 1989. The research dealt with nearly 50 species regarding conditions of occurrence, habitat preference, reproduction and possible conservational management up to 2003. In the investigation of species, chorology was of primary importance. Since 1993 occurrence data have been systematically collected. As a first result, CEU grid-maps of 142 species, including all the rare dendrotaxa in Hungary, were published (Bartha – Mátyás 1995) using grid squares of 10' long. × 6' lat. equalling approx. 12 × 11 km. With organizational and methodological experience, focuses have moved to processing, correction and mapping of reference, herbaria and new field records. A detailed evaluation of the distribution of 34 rare species in Hungary was made and published (Bartha et al 1999). The Department of Botany at the University of West Hungary has been project coordinator of 'Floristic Mapping of Hungary' since 2001. The present study describes actual distribution maps of 20 rare tree- and shrub species with short analyses of their conditions in Hungary.

Occurrence map / rare tree and shrub species / Hungary

Kivonat – Ritka fa- és cserjefajok magyarországi előfordulása. A Nyugat-Magyarországi Egyetem Növénytan Tanszéke 1989 óta kiemelten foglalkozik a hazai dendroflóra ritka taxonjaival. A kutatások 2003-ig mintegy 50 faj élőhelyi és előfordulási viszonyait, szaporodásbiológiáját, természetvédelmi kezelési lehetőségeit érintették. E tevékenységben belül a chorológiai vizsgálatok végig kiemelt fontosságot kaptak, 1993-tól szervezett keretek közt történt az előfordulási adatok gyűjtése, melyek első eredményeként 142 fajról (ezen belül az összes ritka hazai dendrotaxonról) jelent meg térkép a közép-európai flóratérképezési rendszer alapmezőinek (kb. 12×11 km) bontásában (Bartha – Mátyás 1995). E felmérés szervezési és módszertani tapasztalatainak felhasználásával az 1990-es évek közepétől az irodalmi és herbáriumi, valamint az újabb terepi adatok feldolgozására, ezen belül pontosításukra és térképi ábrázolására helyeződött át a hangsúly. Ennek keretében 34 ritka faj magyarországi előfordulásáról adtunk részletes elemzést (Bartha et al. 1999). 2001-től a NYME Növénytan Tanszék a Magyarországi Hálótérképezési Program koordinátor intézménye. Jelen tanulmányunkban 20 ritka fa- és cserjefaj aktualizált előfordulási térképét, illetve a fajok hazai helyzetének rövid elemzését közöljük.

Előfordulási térkép / ritka fa- és cserjefajok / Magyarország

* Corresponding author: bartha@emk.nyme.hu; H-9401 SOPRON, Pf. 132

1 INTRODUCTION

In the course of floristic mapping distribution pattern of a particular taxon or taxa is investigated in a given area. Most of the examined taxa are of species rank, but in certain cases subspecies or other taxonomic categories are also mapped. Besides drawing distribution maps, rendering database to the maps can also be targeted.

Grid maps have a regular grid system, which show the presence or absence of taxa; furthermore, the frequency and the quality of data can also be displayed on a rough scale. Currently this is one of the most frequently applied methods for floristic mapping, utilized for the first time in the Netherlands (Mennema et al. 1989). Floristic mapping carried out in Great-Britain (Perring – Walters 1962) was considered as a prime example, and was followed by European research. The present, continuing floristic atlas series (Jalas – Suominen 1972-1994, Jalas et al. 1996, 1999) is related to the great European flora work (Tutin et al. 1964-1980). It applies a 50 × 50 square kilometre UTM grid to display the distribution of species (and certain subspecies) in Europe. In Central Europe Ehrendorfer – Hamann (1965) were the first to recommend grid based floristic mapping where a grid of geographic longitudes and latitudes serves as topographic reference, which can have a common application. The extension of Central European ‘base-squares’ is 10' longitude × 6' latitude. By dividing them into four parts, the quarters of ‘base-squares’ or the ‘quadrates’ are obtained (5' long. × 3' lat). Depending on the purpose of the research, the basis of floristic mapping can be either the ‘base-squares’ or the ‘quadrates’ (Niklfeld 1971). Several regional projects have already been carried out in West Germany: Haeupler – Schönfelder 1989; East Germany: Benkert et al. 1996; Belgium and Luxemburg: Rompaey – Delvosalle 1979, Czech Republic: Slavík 1986, 1990, 1998; Poland: Zajac – Zajac 1997. They use the methods of the project Mapping Flora of Central Europe, and several local flora atlases have been completed so far. In 1972 Hungary joined the floristic mapping of Central Europe. A database was compiled by processing about 40 floraworks, but only a small amount of the results was published (Borhidi 1984).

Preliminary Research in Hungary

There is only a small number of studies demonstrating distributions of regional dendroflora in Europe. In Slovakia a considerable database about the occurrence data of tree and shrub species (Blatný – Štastný 1959) was completed, but only a patch map of four coniferous species (*Picea abies*, *Abies alba*, *Pinus sylvestris*, *Larix decidua*) and a dot map of two rare Gymnosperms (*Pinus cembra*, *Taxus baccata*) were drawn. All species of dendroflora were mapped in Poland (Browicz 1963-81) and in France (Rameau et al. 1989, 1993) and displayed on patch maps. Furthermore, in France the frequency was shown by a two-degree scale. The most detailed grid maps of tree species significant for forestry were published in Spain (León et al. 1993). There are many publications on rare and endangered tree and shrub species (and also other plant species) considering local scales. On a regional scale an atlas of 61 species in Bavaria (Anon. 1986) represents the occurrence in quadrates and the status of the species as well.

In Hungary the first publication dealing with the distribution of trees and shrubs is a study by Fekete – Blatny (1913, 1914). At the statutory meeting of the International Union of Forest Research Organizations held in Vienna in 1893, elaboration of this work was envisaged. It has frequently been, in international references, and has become an essential source book. Occurrence records of 57 dendrotaxa were displayed within the former borders of Hungary (including nearly the entire Carpathian Basin). It should be noted that localization of species in the vertical zones was given more emphasis than that of their horizontal distribution. Species localities have detailed lists in 14 main geographical units, and 4 maps are enclosed, on which there are dot and/or patch maps of 23 dendrotaxa (such as *Picea abies*, *Abies alba*, *Pinus sylvestris*, *P. nigra*,

P. cembra, *Larix decidua*, *Taxus baccata*, *Fagus sylvatica*, *Quercus pubescens* s. l., *Q. frainetto*, *Q. cerris*, *Castanea sativa*, *Carpinus orientalis*, *Ostrya carpinifolia*, *Alnus viridis*, *Tilia tomentosa*, *Fraxinus ornus*, *Acer obtusatum*, *A. monspessulanum*, *A. tataricum*, *Ilex aquifolium*, *Syringa vulgaris*, *S. josikaea*). At the end of the 1950's occurrence records of 11 important stand-forming tree species (*Pinus sylvestris*, *P. nigra*, *Picea abies*, *Larix decidua*, *Robinia pseudoacacia*, *Fagus sylvatica*, *Carpinus betulus*, *Quercus cerris*, *Q. robur*, *Q. petraea*, *Q. pubescens*) were collected on the basis of the forestry management plans (Járó 1962, 1966). These maps can be considered as special dot maps, in which the frequency of the species is shown by a six-degree scale within communal borders. A note is added to each of the species indicating the focal point of its occurrence, the site requirements and whether it is indigenous. Distribution of all species of the dendroflora in Hungary – except Genus *Rosa* – are shown in a study by Bartha – Mátyás (1995) containing dot maps and patch maps. Concerning 36 important stand-forming and admixed tree species dot maps were drawn, where each dot represents a 1500-hectare-area of forest. The territory of the country was covered by 1,000 dots. This method made frequency demonstration possible using a five-degree scale. These maps are based on the database of the State Forest Service. Methods of Mapping the Flora of Central Europe were applied in case of 106 more rare tree and shrub species. The grid extension was approximately 12.8 × 11.1 km (Central European 'base-squares'). In the maps, different signs mark the natural occurrence, extinction, sub-spontaneous occurrence and uncertain occurrence. The book contains further 11 adventive species, but due to insufficient knowledge no maps were presented. The State Forest Service compiled grid maps of six species and group of species (oak, Turkey oak, beech, black locust, poplar and pine) on the basis of their own database (Szabó 1997, Bán et al. 2002). In these maps the grid units represent 287.5 hectares (1,896 m x 1,517 m). To display frequency, a five-degree scale was used.

2 MATERIALS AND METHODS

In Hungary the plan of drawing grid-based floristic maps for the entire vascular flora was raised again at the turn of the Millennium. Methods were elaborated in detail (Király – Horváth 2000). The inventory of the about 2,800 quadrates covering the country between 2002-2005 is financed by a National Research and Development (R&D) Project (Bartha et al. 2002). The investigation of rare dendroflora worthy of protection in Hungary has been one of the main research topics of the Department of Botany. The compilation of Bartha – Mátyás (1995) was pioneer in showing how essential it is to get reference and herbaria records up-to-date and to use refined scale maps. Research workers of the Department of Botany have collected data of nearly 50 protected or rare dendroflora, involving evaluation of reference data and herbaria sources, and new field data for the years 1995-1998. Unpublished data, such as manuscripts, were also processed. A description of the database of 34 species was published by Bartha et al. (1999), but due to technical problems, no accurate maps were issued. Between the years of 1998-2002 database development was continued, and a number of new records were added. In the meantime, the use of the GIS was being improved. The present study includes grid maps of 20 species and adopts methods applied for Mapping the Flora of Central Europe. So far no distribution maps of these species have been drawn in such a refined scale (6.4 x 5.5 km) in Hungary. In selecting species from the database, besides the especially rare taxa (such as *Carpinus orientalis*), species having more regional records (such as *Salix pentandra*) and species with a large number of records (such as *Alnus incana*) had the preference. The paper presents also examples for different levels of endangered status within one genus. For this reason distribution maps of several species of one genus (such as *Alnus* spp., *Ribes* spp.) are displayed together.

3 RESULTS

Occurrence records are divided into two parts. Data before and after 1990 are separated in the database of rare dendrotaxa and also on the maps. 1990 is the year of reference, because it is the time when botanical field studies intensified, and changed attitudes in forestry and nature conservation in Hungary. For some taxa, plantation or spontaneous occurrences also have map representation. For only a few species occurrences described earlier proved to be extinct, or the records are unconfirmed, however the category of ‘extinct’ is applied only in verified instances. The maps demonstrated in the paper provide opportunities to computer data and to investigate reasons of regression of some species on the basis of the old unconfirmed records. Many new occurrences were found after 1990. As additional information, a short description is accompanying the map of each species. The maps and the database provide essential information for scientists and forest managers investigating biological bases of forest management, and also, for nature conservation experts.

Applied abbreviations:

- 1990 onwards, indigenous occurrence
- Before 1990, indigenous occurrence, not confirmed since 1990
- 1990 onwards, planted or escaped species occurrence
- Before 1990, planted or escaped occurrence, not confirmed since 1990
- + Locality, from where a taxon has certainly become extinct
- Occurrences of uncertain locality (mainly data before 1990, covering possible quadrates)
- ▲ Occurrence of *Cotoneaster* spp. (undefined, either *C. niger* or *C. integerrimus*) (only in Figure 6)

Grey alder [*Alnus incana* (L.) MOENCH] (Figure 1)

Proving the dealpine character of this species, it is more frequent along the rivers originating in the Alps (Danube, Rába, Mura, Dráva), and in the valleys of Hernád and Bodrog rivers, which rise in the Carpathians. In other parts of Hungary only planted stands are known.

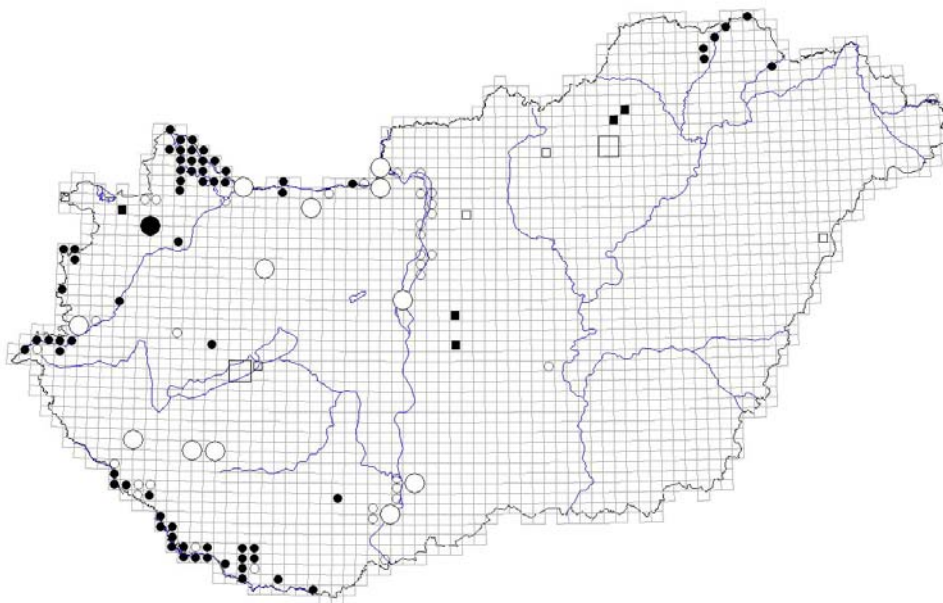

Figure 1. Occurrences of grey alder [*Alnus incana* (L.) MOENCH] in Hungary

Green alder [*Alnus viridis* (CHAIX) DC.] (Figure 2)

In the western part of Órség and in Vendvidék stable populations exist, but records from the bordering areas have not been confirmed recently. Occurrences in the Sopron Hills and Kőszeg Mountains mentioned in other sources are faulty or do not refer to Hungary.

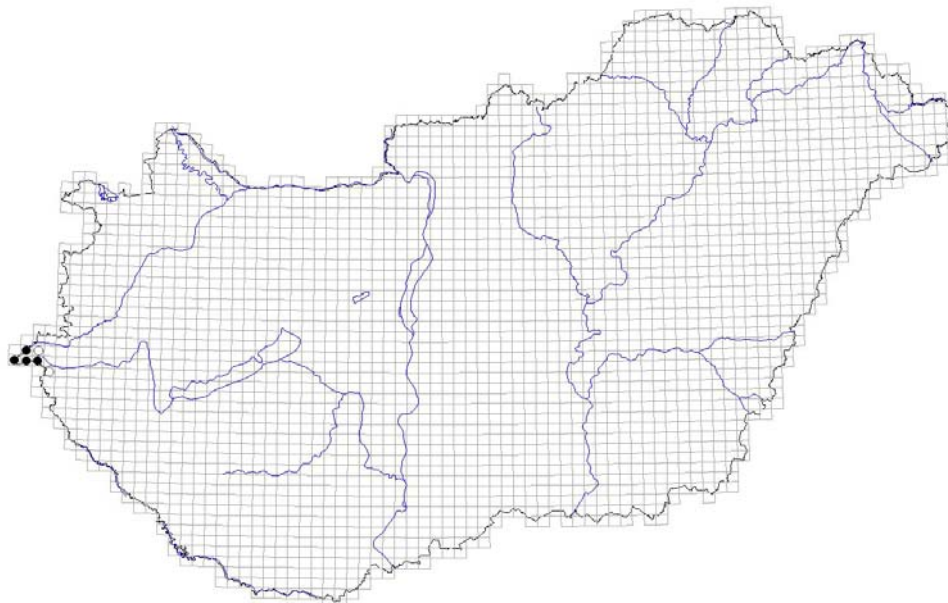

Figure 2. Occurrences of green alder [*Alnus viridis* (CHAIX) DC.] in Hungary

Snowy mespilus [*Amelanchier ovalis* MEDICUS] (Figure 3)

This species exists on dolomite hills of strong sub-Mediterranean character in the Transdanubian Mountains. The main part of its range is in the Bakony and Vértes Mountains. Only two more isolated occurrence sites are known, one in the Keszthely Mountains and the other in the Gerecse Mountains. Since 1990 several new localities of this species have been found owing to intensive research.

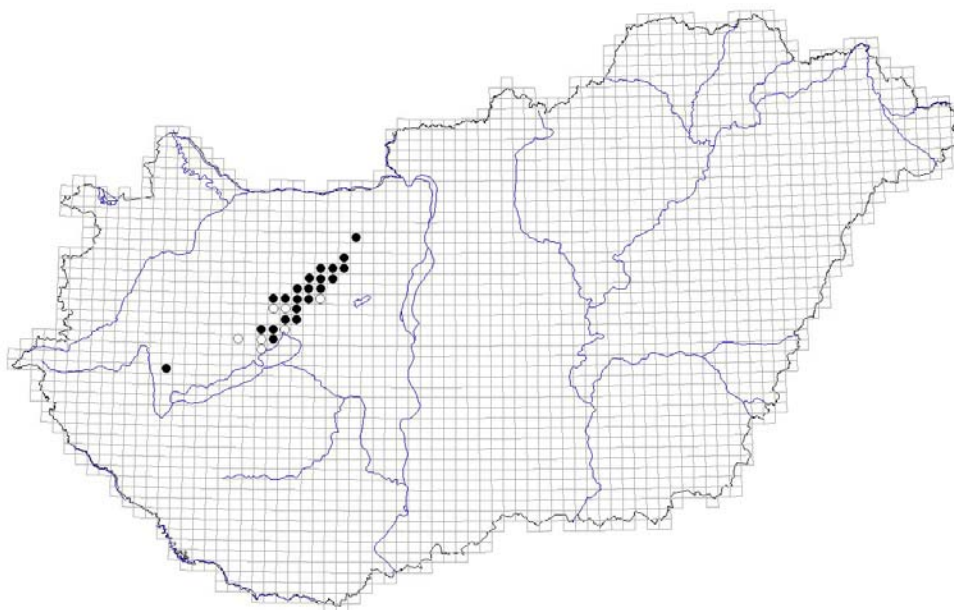

Figure 3. Occurrences of snowy mespilus [*Amelanchier ovalis* MEDICUS] in Hungary

Oriental hornbeam [*Carpinus orientalis* MILL.] (Figure 4)

This periglacial relic species occurs indigenously in the Vértes Mountains (Haraszt-Peak), where it is found in great abundance; while there are planted stands in the Csaplár-forest near Alcsútdoboz.

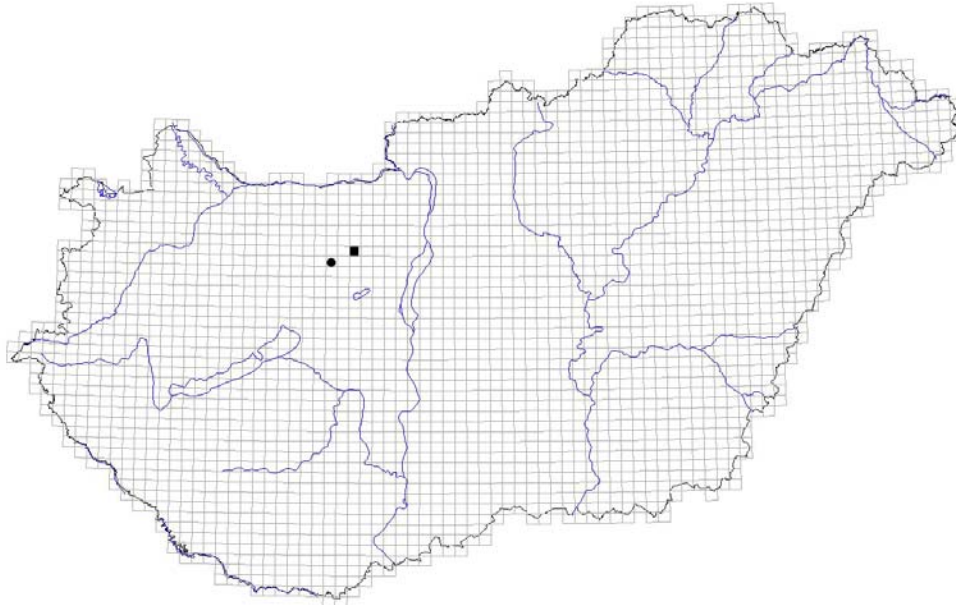

Figure 4. Occurrences of oriental hornbeam [*Carpinus orientalis* MILL.] in Hungary

Scorpion senna [*Coronilla emerus* L.] (Figure 5)

This shrub species is found in calcareous woodlands of the Transdanubian Mountains of sub-Mediterranean character. The number of localities, where it has been found, multiplied after 1990. It was found at many spots in the Bakony Mountains. No records in the Külső-Somogy region has been confirmed since the 1960's.

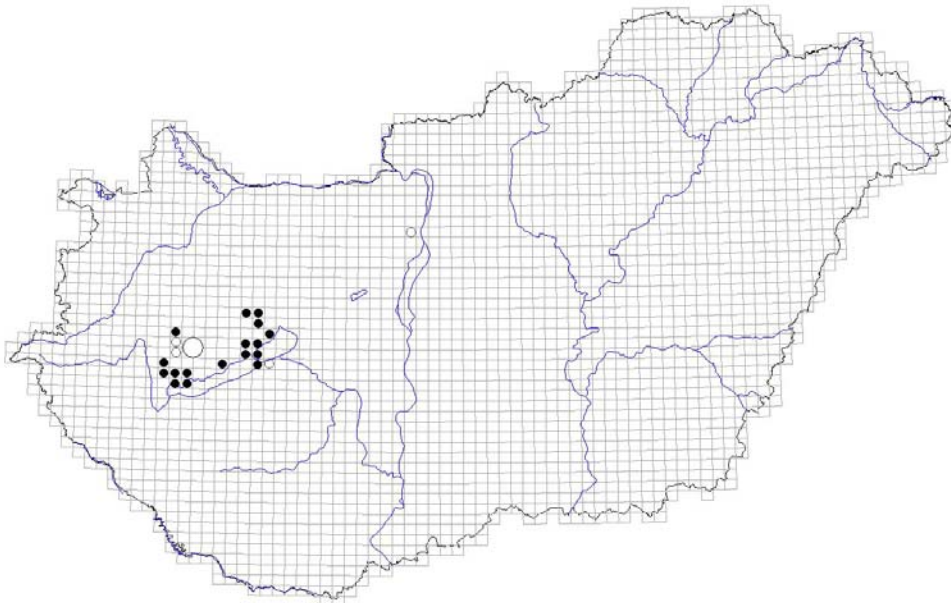

Figure 5. Occurrences of scorpion senna [*Coronilla emerus* L.] in Hungary

Wild common medlar [*Cotoneaster integerrimus* MEDICUS] and black medlar [*Cotoneaster niger* (WAHLBERG) FRIES] (Figure 6 - Figure 7)

This is a pair of species with difficult taxonomy. There is an intermediate form (*C. matrensis* DOMOKOS), which occurs in several literature sources. On the maps only records which were checked after 1990 are shown, for the former reference data or fragmentary herbarium specimens cannot be identified correctly. The so far unchecked records of *C. integerrimus* – *C. niger* are displayed as a separate category.

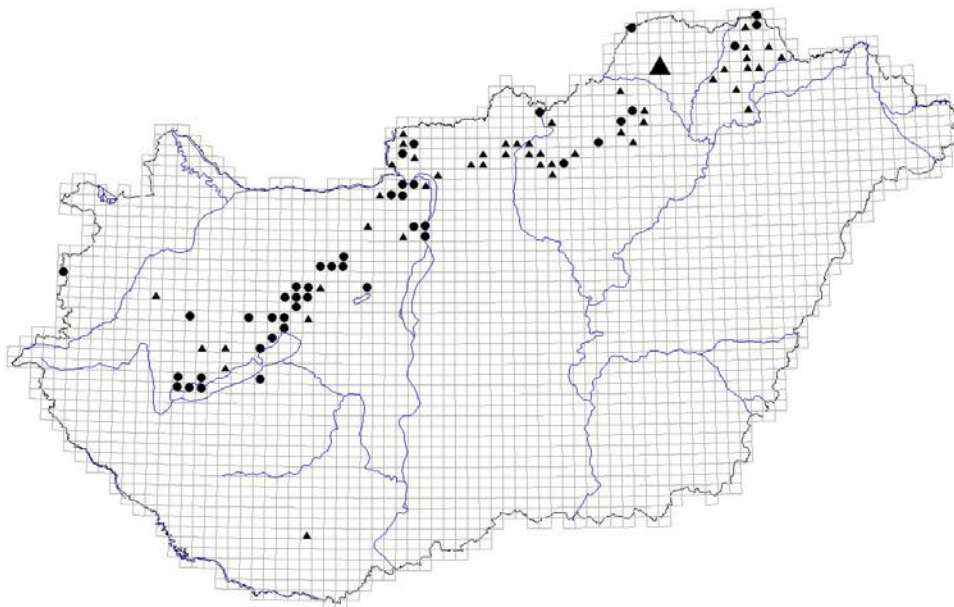

Figure 6. Occurrences of wild common medlar [*Cotoneaster integerrimus* MEDICUS] in Hungary

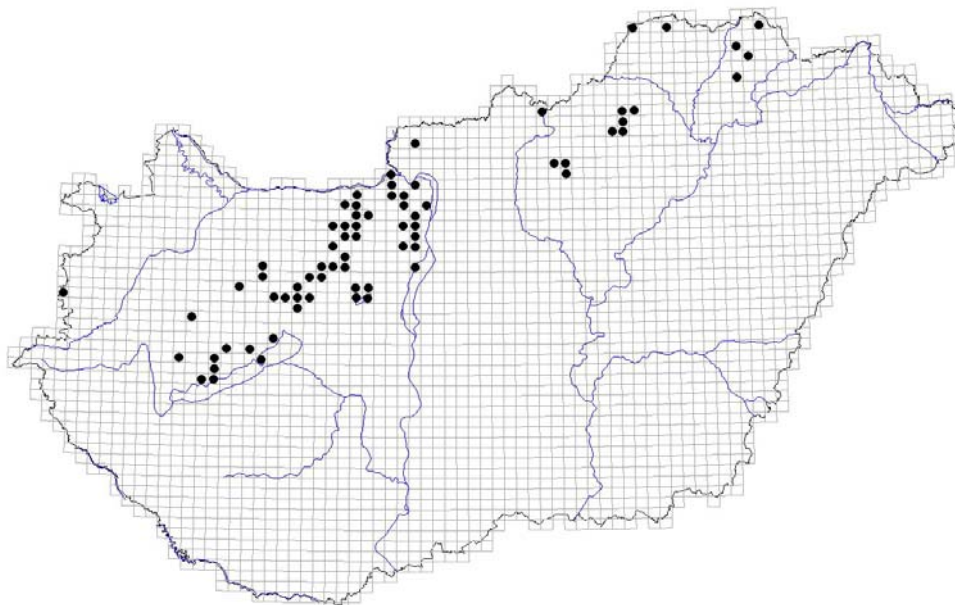

Figure 7. Occurrences of black medlar [*Cotoneaster niger* (WAHLBERG) FRIES] in Hungary

Downy medlar [*Cotoneaster tomentosus* (AITON) LINDLEY] (Figure 8)

Species occur mainly on dolomite bedrock of sub-Mediterranean character of the Transdanubian Mountains. They have not been found lately in the eastern part of the Balaton Uplands. Records of occurrence in the Mecsek Mountains are more than one and a half centuries old. Records from Somogy region, mentioned in other sources, are probably faulty.

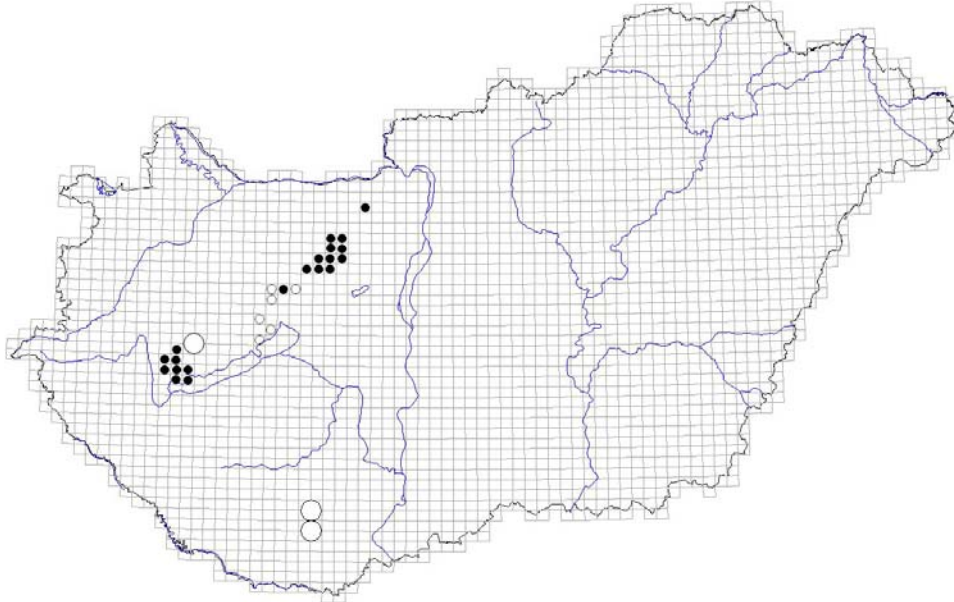

Figure 8. Occurrences of downy medlar [*Cotoneaster tomentosus* (AITON) LINDLEY] in Hungary

Garland flower (*Daphne cneorum* L.) (Figure 9)

Occurrences of the basophilous form have decreased in the Transdanubian Mountains, and new localities have rarely been found since 1990. The acidophilous form (subsp. *arbusculoides* (TUZSON) JÁV.) has stable stands in Órség region, but several disperse populations have already disappeared.

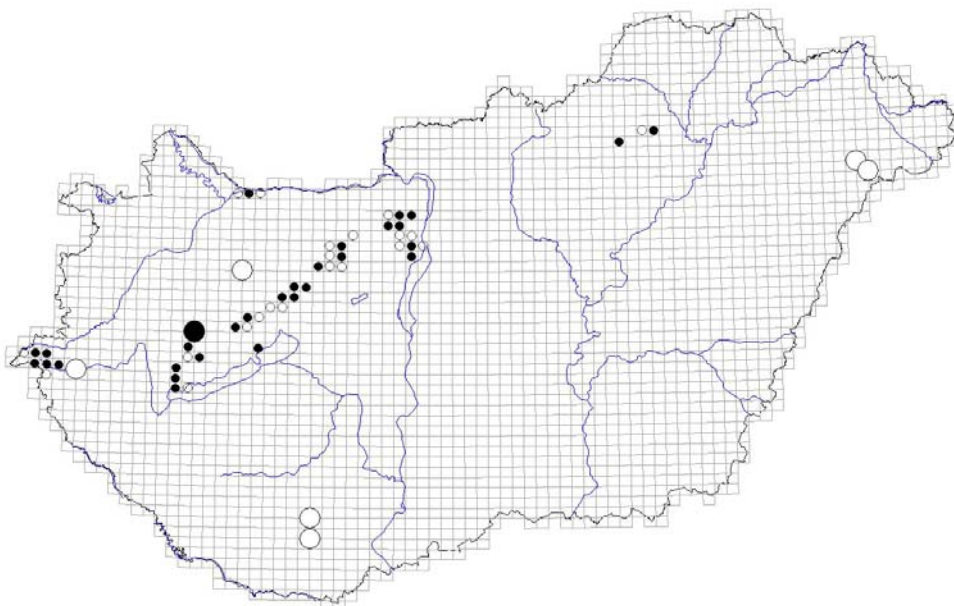

Figure 9. Occurrences of garland laurel [*Daphne cneorum* L.] in Hungary

Sprunge laurel [*Daphne laureola* L.] (Figure 10)

This species can be found at higher elevations of the Transdanubian Mountains of sub-Atlantic, sub-Mediterranean character, and there are stable stands in the Bakony Mountains and Vértes Mountains. The population in the Keszthely Mountains is vulnerable, and the species became extinct from the Börzsöny Mountains long ago.

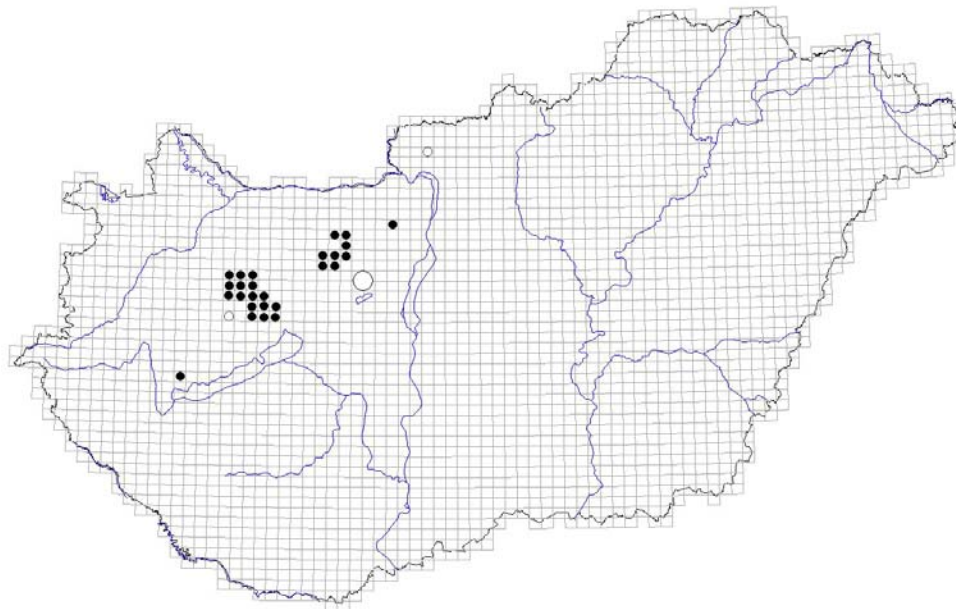

Figure 10. Occurrences of sprunge laurel [*Daphne laureola* L.] in Hungary

Sea grape [*Ephedra distachya* L.] (Figure 11)

It occurs in the sub-Mediterranean forest steppe areas, primarily in the area between the Duna and the Tisza rivers. Some of its former localities, mainly near the capital are disappearing rapidly and the few new localities found after 1990 cannot compensate for losses.

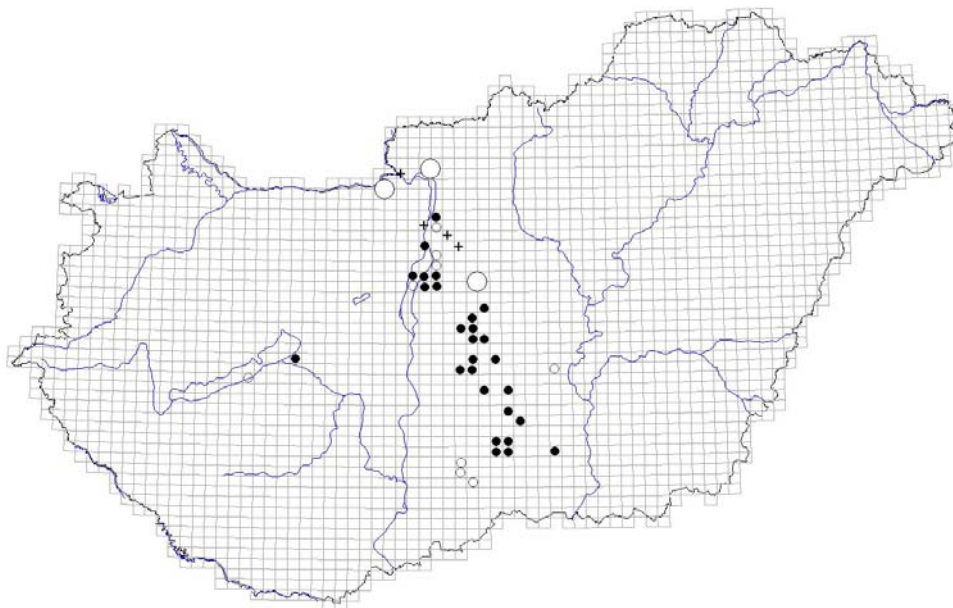

Figure 11. Occurrences of sea grape [*Ephedra distachya* L.] in Hungary

Austrian pear [*Pyrus austriaca* KERNER] (Figure 12)

This taxon has been cultivated for a long time, its localities are situated in the western margin of Transdanubia, and its specimens survived due to cultivation. This species might become much more rare because of the decrease of extensively managed orchards.

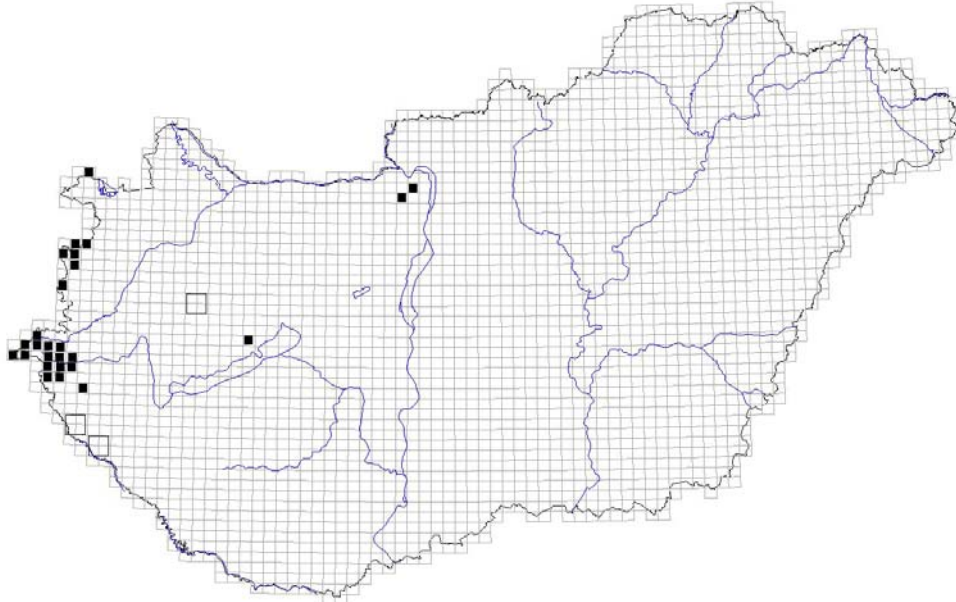

Figure 12. Occurrences of Austrian pear [*Pyrus austriaca* KERNER] in Hungary

Hungarian pear [*Pyrus magyarica* TERPÓ] (Figure 13)

It is a hardly known endemic species of the Hungarian flora, which became known no more than half a century ago. More than half of its former records cannot be confirmed presently, at the same time recent occurrences consist of quite a few individuals.

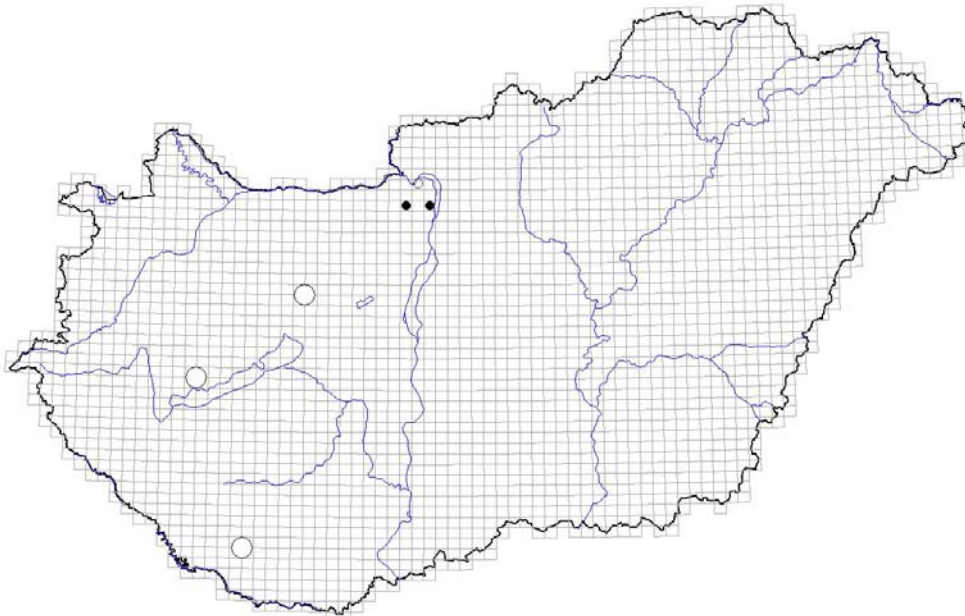

Figure 13. Occurrences of Hungarian pear [*Pyrus magyarica* TERPÓ] in Hungary

Snow pear [*Pyrus nivalis* JACQ.] (Figure 14)

This is a cultural relic species, which had large populations on some spots of the southern sides of the Northern and Transdanubian Mountains in the 1950's. As a result of intensive viticulture and construction work by the 1990's, only a small part of its former records could have been confirmed. The other endangering factor is the introgression with wild pear (*P. pyraeaster* BURGD.). On most of its habitats only hybrid individuals (*P. × pannonica* TERPÓ) can be found.

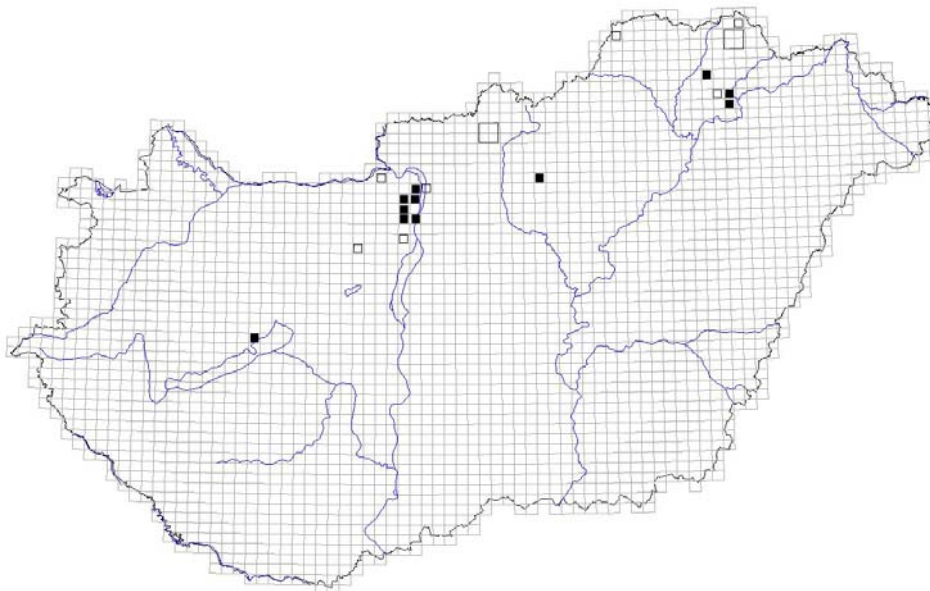

Figure 14. Occurrences of snow pear [*Pyrus nivalis* JACQ.] in Hungary

Rock buckthorn [*Rhamnus saxatilis* JACQ.] (Figure 15)

Having descended from the limestone range of the eastern Alps, it has one occurrence near Sopron, which is the only area of calciferous character in West-Transdanubia. In the inner part of this locality some new subpopulations have been found since 1990, but its marginal stands (in Sopron Hills) have disappeared.

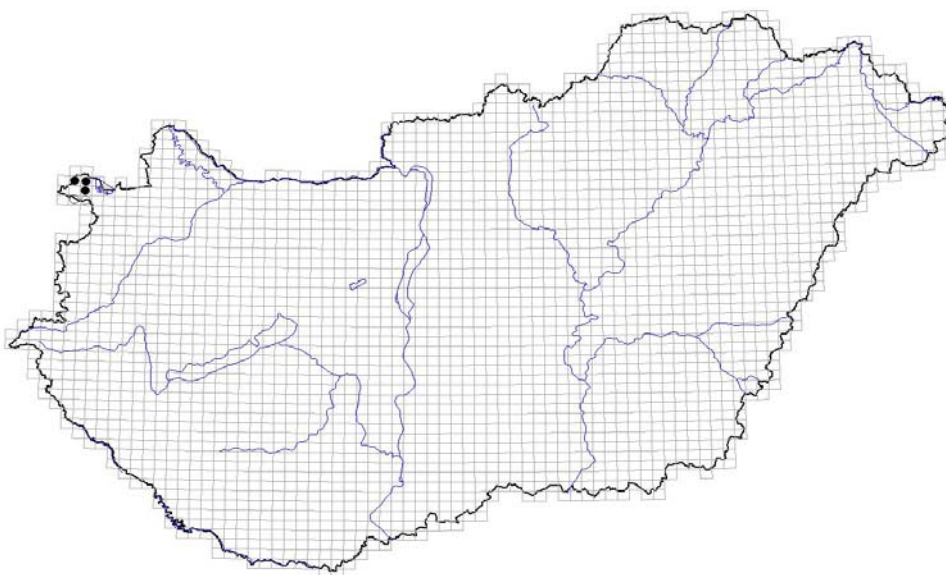

Figure 15. Occurrences of rock buckthorn [*Rhamnus saxatilis* JACQ.] in Hungary

Alpine currant [*Ribes alpinum* L.] (Figure 16)

This glacial relic species survived in the mountainous area of Hungarian Mountains. In the last one and a half decades the number of known localities has doubled, and it was found also in some new areas (such as Mátra Mountains, Torna Karsts).

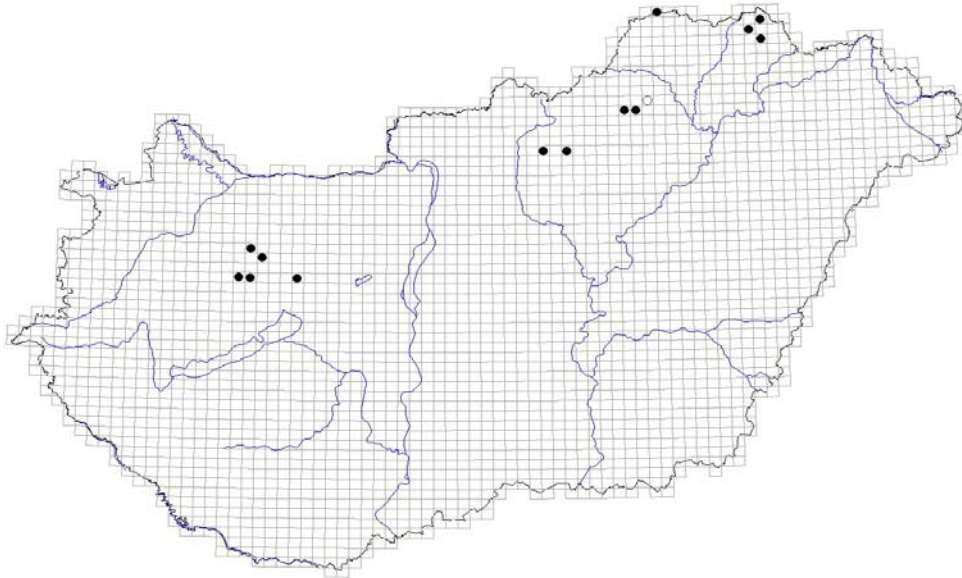

Figure 16. Occurrences of Alpine currant [*Ribes alpinum* L.] in Hungary

Black currant [*Ribes nigrum* L.] (Figure 17)

This species is possibly indigenous along the Danube and in Hanság, several new localities were found after 1990, mainly in Transdanubia. These new occurrences can be explained partly by more detailed field research and partly by the spontaneous expansion of its area. Although in some cases localities of human origin cannot be excluded, on the map all the records are marked as indigenous because of the difficult status estimation.

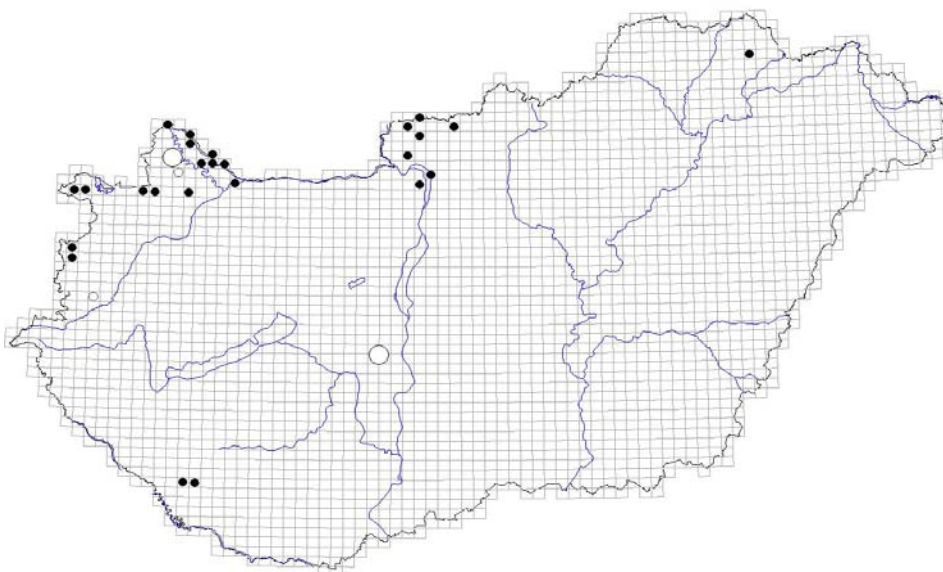

Figure 17. Occurrences of black currant [*Ribes nigrum* L.] in Hungary

Red currant [*Ribes rubrum* L. agg.] (Figure 18)

A northeastern European species, which was established at the beginning of the 20th century as sub-spontaneous introduction, and became a seemingly indigenous element of natural forest associations. Owing to its capability to adapt, *Ribes rubrum* was entered into the Red List of endangered species. During recent research, several new localities were found, so the expansion of this species is still going on.

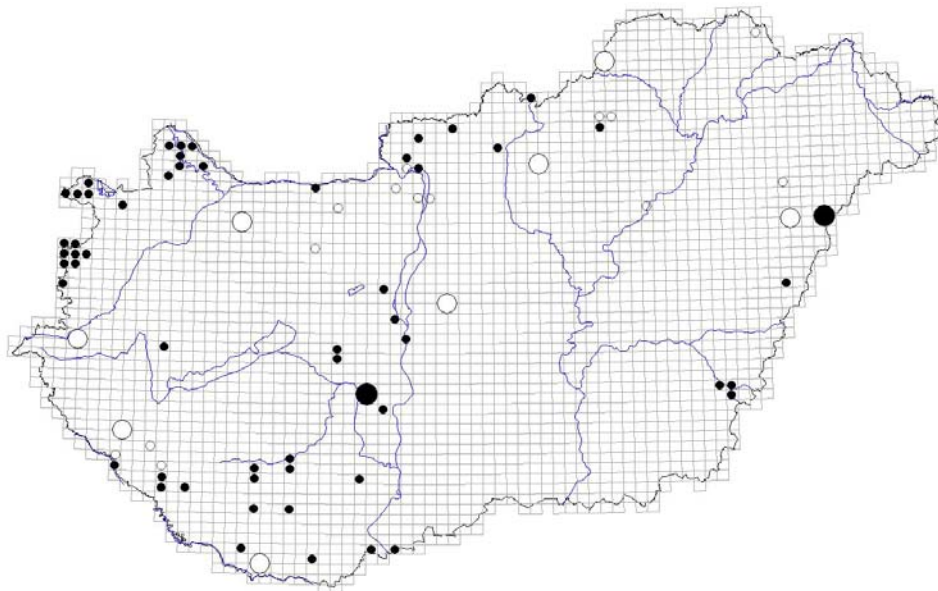

Figure 18. Occurrences of red currant [*Ribes rubrum* L. agg.] in Hungary

Bay willow [*Salix pentandra* L.] (Figure 19)

Populations being relics of colder ages are known on the mires of Eastern Nyírség and Szatmár-Bereg Plain. Some new subpopulations have been found after 1990. All its former occurrences have disappeared on the western side of the Tisza River. Only one locality was discovered, though its indigenous character is questionable. The species might occur in Hanság as well.

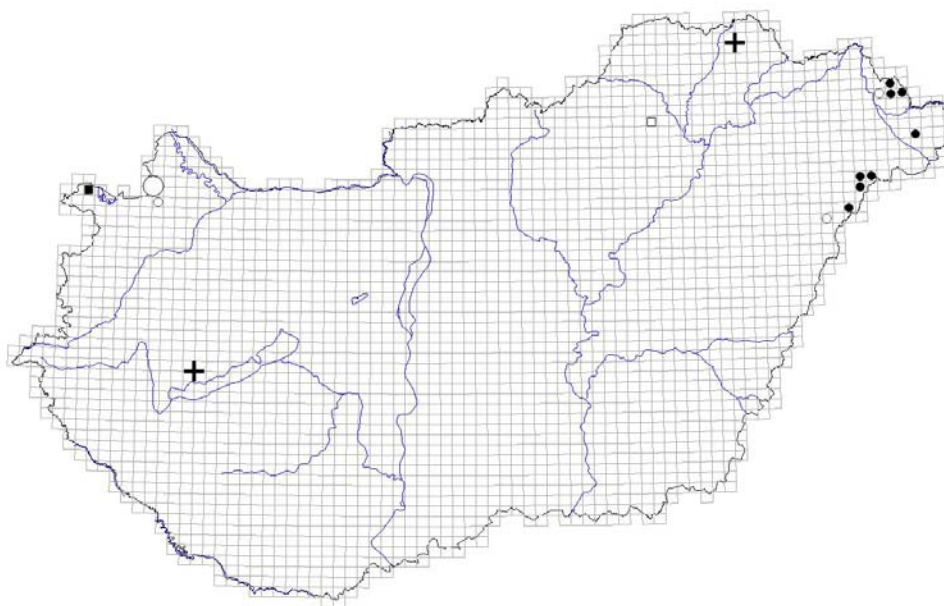

Figure 19. Occurrences of bay willow [*Salix pentandra* L.] in Hungary

Common yew [*Taxus baccata* L.] (Figure 20)

This species has two indigenous occurrences in the Bükk Mountains and in the Southern Bakony Mountains. The latter one belongs to the largest stands of this species in Central Europe. Other records representing few individuals should be considered as subspontaneous.

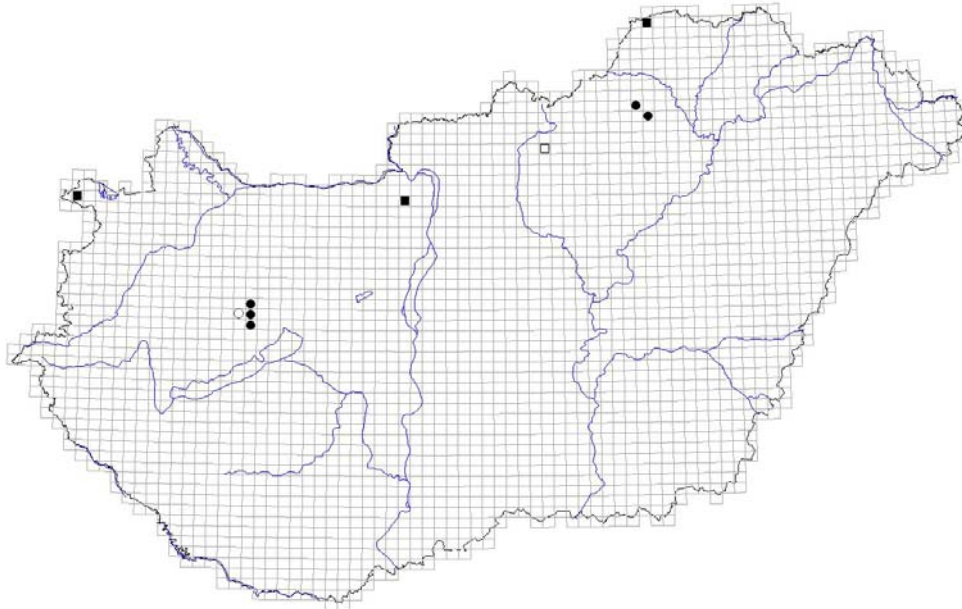

Figure 20. Occurrences of common yew [*Taxus baccata* L.] in Hungary

Acknowledgements: We would like to thank János Bölöni (HAS Ecological and Botanical Research Institute, Vácrátót), Balázs Lesku (Hortobágy NP Directorate, Debrecen) and Attila V. Molnár (University of Debrecen) for their assistance in data processing.

REFERENCES

- ANON. 1986: Förderung seltener und gefährdeter Baum- und Straucharten im Staatswald. Bayerisches Staatsministerium für Ernährung, Landwirtschaft und Forsten, München.
- BÁN, I. – KIRÁLY, P. – PLUZSIK, A. – SZABÓ, P. – WISNOVSZKY, K. – ZÉTÉNYI, Z. (eds.) (2002): Magyarország erdőállományai 2001. Állami Erdészeti Szolgálat, Budapest: 100-105.
- BARTHA, D. – BÖLÖNI, J. – KIRÁLY, G. (eds.) (1999): Magyarország védett és veszélyeztetett fa- és cserjefajai I. Tilia 7: 1-268.
- BARTHA, D. – KIRÁLY, G. – MOLNÁR, Zs. (2002): Magyarország természetes növényzeti örökségének felmérése és összehasonlító értékelése. In: Salamon-Albert, É. (ed.): Magyar botanikai kutatások az ezredfordulón. Pécsi Tudományegyetem Növénytani Tanszék, Pécs: 309-342.
- BARTHA, D. – MÁTYÁS, Cs. (1995): Erdei fa- és cserjefajok előfordulása Magyarországon. Saját kiadás, Sopron.
- BENKERT, D. – FUKAREK, F. – KORSCH, H. (eds.) (1996): Verbreitungsatlas der Farn- und Blütenpflanzen Ostdeutschlands. Gustav Fischer, Jena–Stuttgart–Lübeck–Ulm.
- BLATTNÝ, T. – ŠTASTNÝ, T. (1959): Prirodzené rozšírenie lesných drevín na Slovensku. Slovenské vydavateľstvo pôdohospodárskej literatúry, Bratislava.
- BORHIDI, A. (1984): Role of mapping the flora of Europe in nature conservation. Norrlinia 2: 87-98.
- BROWICZ, K. (1963-1981): Atlas of Distribution of Trees and Shrubs in Poland. Part 1-32. Polska Akademia Nauk., Poznan.

- EHRENDORFER, F. – HAMMAN, U. (1965): Vorschläge zu einer floristischen Kartierung von Mitteleuropa. *Ber. d. Deutsch. Bot. Ges.* 78: 35-50.
- FEKETE, L. – BLATTNY T. (1913): Az erdészeti jelentőségű fák és cserjék elterjedése a Magyar Állam területén. Joerges, Selmecbánya.
- FEKETE, L. – BLATTNY T. (1914): Die Verbreitung der forstlich wichtigen Bäume und Sträucher im Ungarischen Staate I–II. Joerges, Schemnitz.
- HAEUPLER, H. – SCHÖNFELDER P. (eds.) (1989): Atlas der Farn- und Blütenpflanzen der Bundesrepublik Deutschland. Verlag Eugen Ulmer, Stuttgart.
- JALAS, J. – SOUMINEN J. (1972-1994): Atlas Florae Europaeae I-X. The Committee for Mapping the Flora of Europe and Societas Biologica Fennica Vanamo, Helsinki.
- JALAS, J. – SOUMINEN, J. – LAMPINEN R. (1996): Atlas Florae Europaeae XI. The Committee for Mapping the Flora of Europe and Societas Biologica Fennica Vanamo, Helsinki.
- JALAS, J. – SOUMINEN, J. – LAMPINEN, R. – KURTTO, A. (1999): Atlas Florae Europaeae XII. The Committee for Mapping the Flora of Europe and Societas Biologica Fennica Vanamo, Helsinki.
- JÁRÓ, Z. (1962): A fafajok hazai elterjedése. In: Erdészeti termőhelyfeltárás és térképezés. Akadémiai Kiadó, Budapest. 117-136.
- KIRÁLY, G. – HORVÁTH, F. (2000): Magyarország flórájának térképezése: lehetőségek a térképezés hálórendszerének megválasztására. *Kitaibelia* 5: 357-368.
- LEÓN, A., – MIGUEL, J. de – REGATO, P. (1993): Geographical distribution of the spanish forest species. Departamento de Sistemas Forestales I.N.I.A., Madrid.
- MENNEMA, J. – QUENÉ-BOTERENBROOD, A.J. – PLATE, C.L. (eds.) (1985): Atlas van de Nederlandse Flora II. Zeldzame en vrij zeldzame planten. Bohn, Scheltema u. Holkema, Utrecht.
- NIKLFIELD, H. (1971): Bericht über die Kartierung der Flora Mitteleuropas. *Taxon* 20: 545-571.
- PERRING, F.H. – Walters, S.M. (eds.) (1962): Atlas of the British Flora. Thomas Nelson and Sons, Cambridge.
- PERRING, F.H. – Walters, S.M. (eds.) (1990): Atlas of the British Flora. Repr. of the 3. editions, Botanical Society of the British Isles, London.
- RAMEAU, J.C. – MANSION, D. – DUMÉ, G. (1989, 1993): Flore forestière Française I-II. Institut pour le développement forestier, Paris.
- ROMPAEY, E. van – DELVOSALLE, L. (1979): Atlas de la Flore Belge et Luxembourgeoise. Atlas van de Belgische en Luxemburgse Flora. Jardin Botanique National de Belgique, Bruxelles.
- SLAVÍK, B. (1986, 1990): Fytokartografické syntézy CR I-II. Phytocartographical Syntheses of the Czech Republic. Botanický ústav CSAV, Průhonice.
- SLAVÍK, B. (1998): Phytocartographical Syntheses of the Czech Republic III. Academia, Praha.
- SZABÓ, P. (ed.) (1997): Magyarország erdőállományainak főbb adatai 1996. Állami Erdészeti Szolgálat, Budapest: 93-103.
- TUTIN, T.G. – HEYWOOD, V.H. (eds.) (1964-1980): Flora Europaea I-V. University Press, Cambridge–Sydney–New York.
- ZAJĄC, A. – ZAJĄC, M. (1999): Mapping projects of vascular plants distribution in Poland. *Acta Bot. Fennica* 162: 61-66.

Study of Gap-phase Regeneration in a Managed Beech Forest: Relations between Tree Regeneration and Light, Substrate Features and Cover of Ground Vegetation

Barbara MIHÓK^{a*} – László GÁLHIDY^b – Kristóf KELEMEN^a – Tibor STANDOVÁR^a

^a Department of Plant Taxonomy & Ecology, Eötvös Loránd University, Budapest, Hungary

^b Production Biology Research Group, Hung. Acad. of Sci. – University of West Hungary, Sopron, Hungary

Abstract – Gap formation by wind is a characteristic disturbance event in European beech forests. Changes in abiotic environmental variables depend on gap size and different site features. The aim of this gap-study is to test the effect of gap size on spatial distribution of abiotic environmental variables and on the abundance and distribution of tree regeneration. Eight experimental gaps – three large (d: 35-40 m) and five small (d: 10-15 m) – were created in a mesotrophic beech forest in winter 2000/2001. Data were collected systematically in 1m x 1m quadrats before gap creation and subsequently on five occasions. Hemispherical photographs were used to estimate relative light intensity along a gap-under-canopy transect. First results of this long-term study suggest that establishment of beech seedlings is negatively influenced by dispersal limitation in large gaps and amount of slash as well, while it seems to be insensitive to environmental conditions. Development of beech saplings is accelerated by increased light intensity, and by protective effect of dense herb layer in opened sites. *Salix caprea* – as a light demanding species – appears mostly in the centre of large gaps.

artificial gap / PACL / *Fagus sylvatica*

Kivonat – A fás újulat vizsgálata kezelt bükkös erdő lékjeiben: az újulat valamint a fény, a talajfelszíni jellemzők és az aljnövényzeti borítás összefüggései. A széldöntés által kiváltott lékképződés jellemző bolygatási jelenség bükk által dominált erdőkben. A lékekben az abiotikus környezeti változók alakulása a lékmérettől és a termőhely különböző tényezőitől függ. A vizsgálat célja annak megállapítása, hogy a lékméret hogyan befolyásolja az abiotikus környezeti tényezők térbeli mintázatát, valamint a fás újulat tömegességi és térbeli viszonyait. Bükk által dominált állományban nyolc kísérleti léket hoztunk létre 2000/2001 telén: három nagyot (átm: 35-40 m), és öt kicsit (átm: 10-15 m). Az adatgyűjtés szisztematikus módon, 1m x 1m-es kvadrátok segítségével történt a léknyitást megelőzően, majd öt további felvétel során. A relatív megvilágítottság becsléséhez halszemoptikás felvételeket készítettünk a léken áthúzódó transzekt mentén. A vizsgálat első eredményei szerint a bükk felújulását nagy lékekben negatívan befolyásolja a magterjedés korlátozottsága, valamint a gallyak mennyisége, miközben a környezeti változók hatása csekély. A bükk fejlődését a fényintenzitás növekedése valamint a sűrű aljnövényzet védelme elősegíti. A kecskefűz, mint fényigényes faj leginkább a nagy lékek közepén jelenik meg.

mesterséges lék / PACL / *Fagus sylvatica*

* Corresponding author: babar@axelero.hu; H-1119 BUDAPEST, Pázmány P. u. 1/c

1 INTRODUCTION

In Hungarian beech forests formation of gaps by windthrow is a characteristic natural disturbance event. Other factors that can generate gaps: snow, fire, insects, fungi, etc. (Peterken 1996, Somogyi 1998). Resulting abiotic and biotic conditions can be very different both within individual gaps – depending on gap size – and among different sites (Canham 1989, Collins and Pickett 1987, Collins and Pickett 1988, Holeksa 2003, Kwit and Platt 2003, Nakashizuka 1985, Runkle 1989, Poulson and Platt 1989, Platt and Strong 1989, Vitousek and Denslow 1986, Denslow and Spies 1990). Consequently, it is not easy to predict how herbaceous and woody species react to gap formation.

Different explanations and theories have been published on how species establish and survive in gaps of different forest types all around the world. Theory of *gap partitioning* emphasizes the role of the resource gradients (e.g. light) from beneath intact canopy to the centre of the gap, which is too broad to be dominated by one species (Gray and Spies 1996). Establishment and growth of different tree species are therefore correlated with gap size and within-gap position (Brokaw and Busing 2000, Busing and White 1997). The *microsites as regeneration niches* concept emphasizes the role of specific substrates (e.g., logs, pits and mounds), which can be important as regeneration niches. Heterogeneity observed at the seedling scale (< 10 cm) often overrides larger-scale environmental gradients (>2 m) associated with gap size and within-gap position (Gray and Spies 1997).

This paper shows preliminary results of a long-term experiment focusing on gap-phase regeneration in a submontane beech forest in Hungary. The aim of our study is to investigate how gap size influences the spatial distribution of relative light intensity in gaps; the effect of relative light intensity, and pattern of substrate types on the distribution and abundance of regeneration of tree species.

Our questions are the following: 1. Are there any significant differences in the composition and abundance of regeneration species in small versus large gaps and within each gapsize class during the first 4 years? 2. How do environmental factors (total, direct and diffuse relative light intensity; proportions of substrate features) influence the occurrence and the abundance of tree species?

Although empirical observations and development of methods of natural regeneration using group selection are available already in historic forestry literature (e.g. Gayer 1895, Roth 1935), the lack of scientific data justified the initiation of experiments focusing on the impact of group selection in Hungarian beech forests. It is expected that the ongoing gap-experiments would provide valuable results for the forestry practice of this region.

2 MATERIALS AND METHODS

2.1 Study area

The study was carried out on the east-northeast-facing slope of the Szén-patak Valley in the Börzsöny Mountains, Northern Hungary (47.9°N, 18.9°E). Elevation is 540-610 m a.s.l., mean annual temperature is 8°C, mean monthly temperature is –3.5 °C and 18 °C in January and in July, respectively. Annual precipitation is 700-800 mm. Bedrock is andesite, on which medium deep brown forest soil has developed. The experimental stand belongs to the mesotrophic submontane beech forest type, in which beech (*Fagus sylvatica*) is monodominant, common ash (*Fraxinus excelsior*), Norway maple (*Acer platanoides*), sycamore (*Acer pseudoplatanus*), field maple (*Acer campestre*), lime (*Tilia cordata*, *Tilia platyphyllos*) and hornbeam (*Carpinus betulus*) are present in small amounts. The more or

less homogeneous tree stand is approx. 80 years old with average tree height and dbh of 25 m, and 30 cm, respectively. Under the homogenous beech canopy, the herb layer is rather poor. The most abundant vascular species include *Mycelis muralis*, *Luzula luzuloides*, *Carex pilosa*, *Epilobium montanum*, *Mercurialis perennis*, *Hieracium sp.*, *Athyrium filix-femina* and *Dryopteris filix-mas*. Spring geophytes are sparse. Game pressure is high, tree seedlings and saplings are greatly affected by intensive browsing. Advance regeneration (>1 m) is poor. The area has been under forestry management using shelterwood regeneration system for a long time. At present it is managed by Ipoly Erdő Co.

2.2 Methods

The location of eight circular artificial gaps – three large (diameter approx. 35-40 m, H:D, i.e. ratio of tree height of the surrounding canopy trees and diameter of gap = 1:1,5) and five small (diameter approx. 10-15 m, H:D = 1:0,5) – were selected in autumn 2000. Gaps were created after the first survey (August 2000) in February 2001. We used a systematic sampling design, with 5-meter grid resolution and 1 x 1 m quadrats. As *Figure 1* shows, each large gap contains 123 quadrats, whereas small gaps contain 64 quadrats each. We sampled each year 689 quadrats except in 2004, when every second quadrat (altogether 355) was sampled.

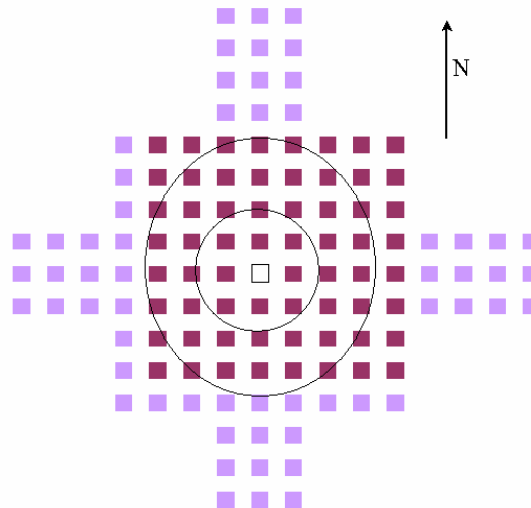

Figure 1. Sampling design in small (dark cells) and large gaps (light cells). 1x1 m quadrats are symbolised by filled rectangles, gaps are symbolised by circles. Distance between quadrats is 5 m.

Vegetation data were recorded on 6 occasions (in Sept.-Oct. 2000, May/Sept.-Oct. 2001, May/Sept.-Oct. 2002, Aug.-Sept. 2004). In each quadrat the following data were recorded: the number of individuals for all tree species in 4 size classes (0-10 cm, 10-20 cm, 20-50 cm, >50 cm) and the percent cover of each herbaceous species (including chamaephytons). On each occasion we determined the cover of each herbaceous species using visual estimation in each quadrat. *Coverage of different substrate types* (intact soil, mineral soil, coarse woody debris-CWD, living tree stem or exposed root, stone) were recorded in spring 2001 and 2002 and autumn 2004 in each quadrat (*Figure 2*). *Hemispherical photographs* were taken at 70 cm height above ground in the sample quadrats along N-S, E-W transects. The transects crossed each other at the centre of the gaps. Altogether 101 photos taken in 2002 were used to calculate relative light intensity (in Percent of Above Canopy Light, PACL). Photos were analysed using a Windows-based software, hemIMAGE developed by Andreas Brunner

(Brunner 2000). Relative light intensity (in PACL) was calculated for a given period of time in a certain location. With hemIMAGE the direct and the diffuse light can be calculated separately for a given point, assuming (based on meteorological data) that 0,5 of the Above Canopy Light (ACL) is the diffuse light component. We calculated the PACL for the period from March 1 to October 31. Different light intensity zones were distinguished within each gap based on diffuse PACL as follows: Z1 – 0-10% diffuse PACL (under canopy); Z2 – 10-20% diffuse PACL (in centre of small gaps and at the edge of large gaps); Z3- >20% diffuse PACL (in centre of large gaps). These zones were used for analysing species abundances.

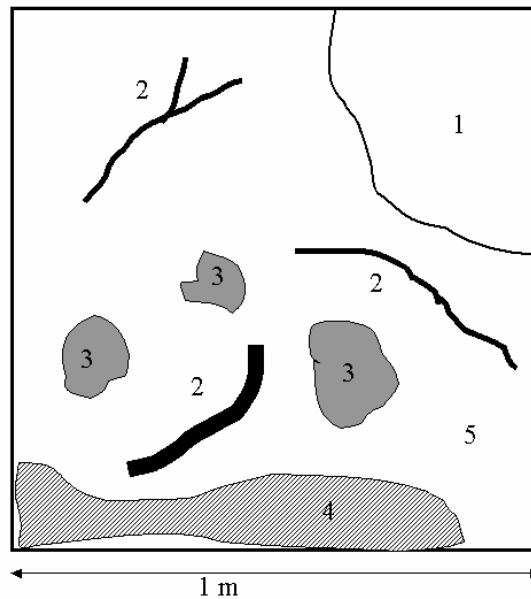

Figure 2. Registered substrate types in each quadrat:

- 1: Living tree trunk or exposed root, 2: Coarse woody debris (CWD), 3: stone, 4: surfaces without litter cover (mineral soil), 5: intact soil (covered by litter, not disturbed)

Canonical correspondence analysis with Canoco for Windows 4.5 software was carried out as multivariate analysis of data in 2004. Abundance of tree species and abiotic variables recorded in quadrats (percent of intact soil, mineral soil, stone, tree, coarse woody debris, coverage of herbaceous plant species and light zones) were included in the analysis. *Nonparametric statistical analysis* – Mann-Whitney U test – was used to compare the recorded vegetation and environmental variables between small versus large gaps. Interactions between abiotic factors and species abundances recorded in 2004 were tested by calculating Spearman Rank Order correlation.

3 RESULTS

Results from hemispherical photo analyses show that under the homogeneous beech canopy relative light intensity in Percent of Above Canopy Light (PACL) for the given vegetation period is around 5-10% (*Table 1a, 1b*). Small and large gaps are significantly ($p < 0,001$, Mann-Whitney U Test) different in terms of total, diffuse and direct PACL values. As *Tables 1a* and *b* show, their minimum values, characterising dense beech canopy, are similar, but maximum PACL values are different. In the centre of gaps much higher proportion of ACL reaches the ground in large gaps than in small ones (about 20% more, both with direct and diffuse light components). The light environment near the edges of large gaps is similar to the brightest part of small gaps.

Table 1a. Descriptive statistics of relative light intensity (in Percent of Above Canopy Light, PACL) in small gaps

	Valid N	Mean	Median	Minimum	Maximum	Range	Variance	Std.Dev.
DIRECT	56	6.8	4.4	1.4	19.8	18.4	0.2	4.9
DIFFUSE	56	10.3	9.9	4.5	16.4	11.9	0.1	3.2
TOTAL	56	8.6	8.5	3.9	14.8	10.9	0.1	2.6

Table 1b. Descriptive statistics of relative light intensity (in Percent of Above Canopy Light, PACL) in large gaps

	Valid N	Mean	Median	Minimum	Maximum	Range	Variance	Std.Dev.
DIRECT	50	14.2	8.7	0.7	39.3	21.8	1.5	12.1
DIFFUSE	50	19.2	18.3	5.0	36.4	19.9	1.2	10.8
TOTAL	50	16.7	16.1	3.8	34.6	17.7	0.9	9.7

On average, more diffuse light reaches the ground than direct sunlight from the sunbeams in most of the sample plots. However, it can vary in certain part of the gaps.

The pattern of diffuse PACL is influenced by the structure of the surrounding stand and it also reflects gap geometry. In the centre of small gaps diffuse PACL is ca. 15%, in large gaps diffuse PACL values vary between 30-36%. At the edges it is ca.10% in small and ca. 20-25% in large gaps. Relative light under canopy intensity decreases below 10% within 10-15 meters, i.e. 0,5*tree-height from the edge.

Direct sunlight reaches the ground for longer periods in the N, N-W part of the gaps during the whole growing season. In small gaps direct PACL reaches 15-19% in the N parts of the gap, in large gaps direct PACL can reach 32-36%.

Total cover of herbaceous species has shown considerable increase in 4 years (Table 2). The highest increase is characteristic in gap centres (both of large and small gaps). Most abundant herbaceous species were: *Atropa bella-donna*, *Carex remota*, *Cirsium arvense*, *Epilobium montanum*, *Fragaria vesca*, *Hypericum perforatum*, *Rubus fruticosus*, *Rubus idaeus*, *Scrophularia nodosa*, *Stachys sylvatica*, *Urtica dioica*.

Table 2. Mean cover (mean±st. err. in percents) of quadrats in small and large gaps in different light zones at consecutive sampling dates. (Z1: light zone of 0-10% diffuse PACL, Z2: light zone of 10-20% diffuse PACL, Z3: light zone of 20%< diffuse PACL)

	Small gaps Z1	Large gaps Z1	Small gaps Z2	Large gaps Z2	Large gaps Z3
No of samples	239 (117 in 2004)	113 (61 in 2004)	81 (43 in 2004)	115 (61 in 2004)	141 (73 in 2004)
2000 autumn	0,3 ±0,1	0,01 ±0,01	0,03 ±0,02	0,04 ±0,02	0,01 ±0,01
2002 autumn	3,0 ±0,7	0,9 ±0,5	22,9 ±3,9	6,4 ±1,4	42,3 ±3,2
2004 autumn	3,5 ±0,9	2,4 ±0,7	33,8 ±5,4	17,1 ±3,9	52,3 ±4,7

Regeneration was very sparse in 2000 before gap creation, with little difference among gaps. Next year there was only a small development in number, but in autumn 2002 we found significant changes because of the beech mast in 2001 (Figure 3). As a consequence, in 2004 taller beech seedlings was found in relatively high number. Regeneration of other species (e.g. *Salix caprea*, *Fraxinus excelsior*, *Acer spp.*, *Tilia ssp.*) was even sparser with stochastic

differences among gaps and years. *Salix caprea* appeared in considerable amount in 2002, however, in 2004, only individuals of larger size classes (> 10 cm) were found in gaps.

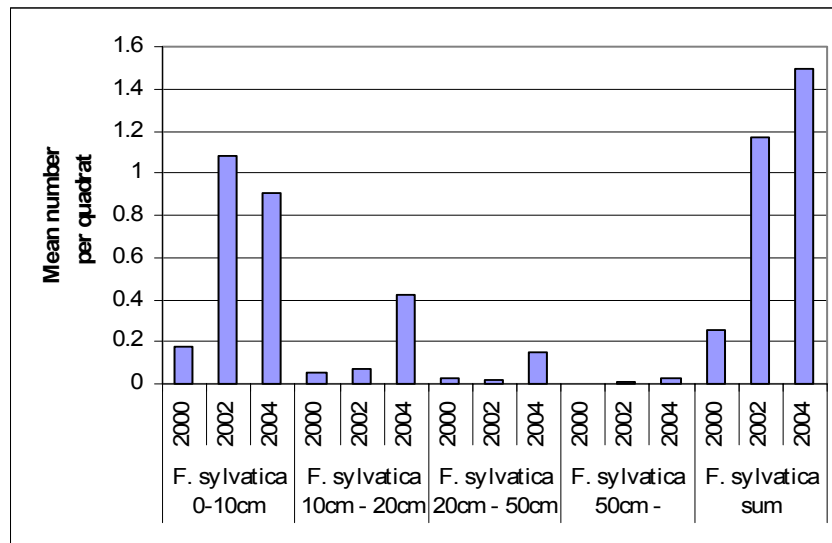

Figure 3. Mean number of beech individuals per quadrat (from all of the gaps) in 2000, 2002 and 2004

Canonical correspondence analysis (Figure 4) showed the relationship between abiotic and biotic variables for data of 2004. All abiotic variables (percent of intact soil, mineral soil, stone, tree, coarse woody debris, coverage of herbaceous plant species and light zones as nominal variables) were included in the model. The following variables were added to the model as significant variable: coverage of herbaceous species (plantsum) (explaining variance of 0,3 of 0,36 at $p = 0.002$, F-ratio = 29.10, number of permutations = 499), percentage of living tree basal area in quadrats (explaining variance of 0,02 of 0,36 at $p = 0.07$, F-ratio = 2.12; number of permutations = 499), Axis 1 and 2 cover the cumulative percentage variance of species-environment relation and 14 % of variance of species data. Axis 1 mostly correlates (0.99) with coverage of herbaceous species (plantsum), while axis 2 seems to be mostly determined by living tree basal area percent (0.99). According to the results among *Fagus sylvatica* seedlings and saplings, larger size classes show correlation with increasing plant coverage, together with *Salix caprea* saplings. Occurrence and coverage of living canopy trees correlates with *Fraxinus excelsior* saplings, while beech saplings between 10 and 20 cm mainly occur where canopy trees are not present.

Abundance of seedlings and saplings by size classes reflect different changes in the three light zones. There are significant – though adverse – changes in the abundance of small (<10 cm) seedlings,. There is an increase in seedling numbers regardless of the zones in both small and large gaps (Figure 5a). Increase is much higher in case of small gaps. Results show similar pattern concerning the saplings between 10-20 cm (Figure 5b). In case of saplings taller than 20 cm there is an extraordinary high increase (Mann-Whitney U Test, $p < 0.05$, see Figures. 5c, 6.) in the abundance in the brightest zone of large gaps (where diffuse PACL is above 20%). These individuals originate from small saplings of year 2000 (see Figure 5a). If plots in 2004 in gaps and under canopy are compared concerning gap size, our results show that in small gaps there is no difference in abundance of beech seedlings (<10 cm) between in-gap or under-canopy plots, while in large gaps amount of seedlings is lower in in-gap plots than under canopy plots (Mann Whitney U Test, $p = 0.03$).

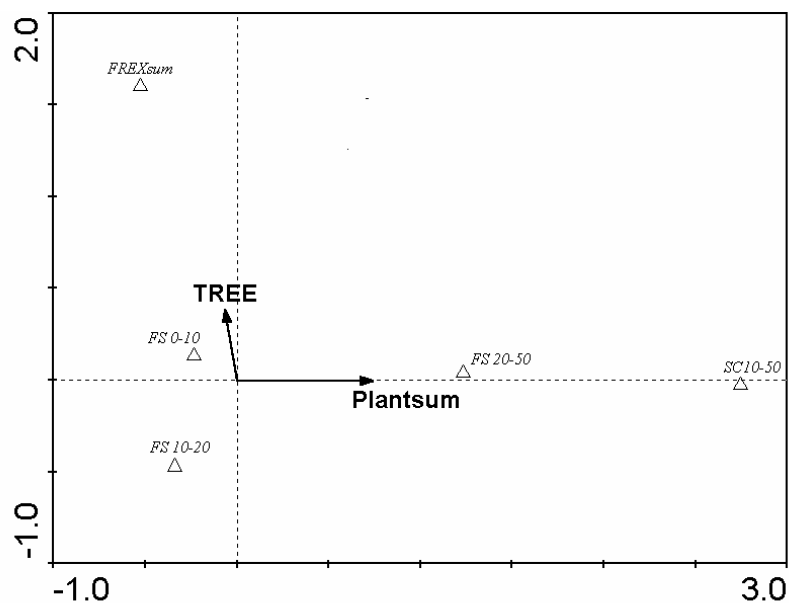

Figure 4. Canonical correspondence analysis for 2004 data.
 (FS 0-10: *Fagus sylvatica* seedlings, <10 cm, FS10-20: *Fagus sylvatica* 10-20 cm,
 FS20-50: *Fagus sylvatica* 20-50 cm, SC10-50: *Salix caprea* 10-50 cm,
 TREE: coverage of living canopy tree stems in quadrats,
 Plantsum: total cover of herbaceous plants)

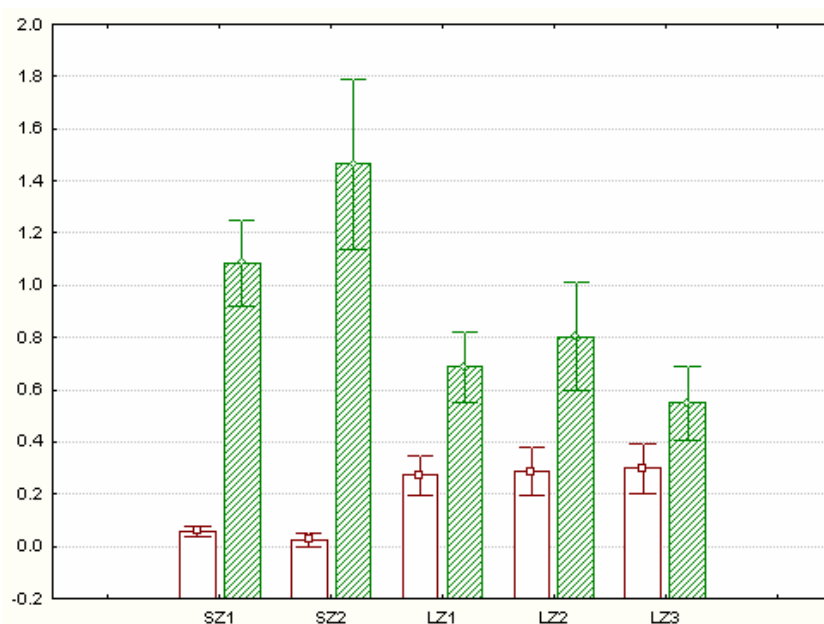

Figure 5a. Average number of *Fagus sylvatica* seedlings (0-10cm) per quadrat according to light zones in small and large gaps in 2000 and in 2004.
 (Columns represent mean, whiskers represent $\pm 1*SE.$, S: small gaps, L: large gaps, Z1-Z3: zones, empty columns: year 2000, shaded columns: year 2004)

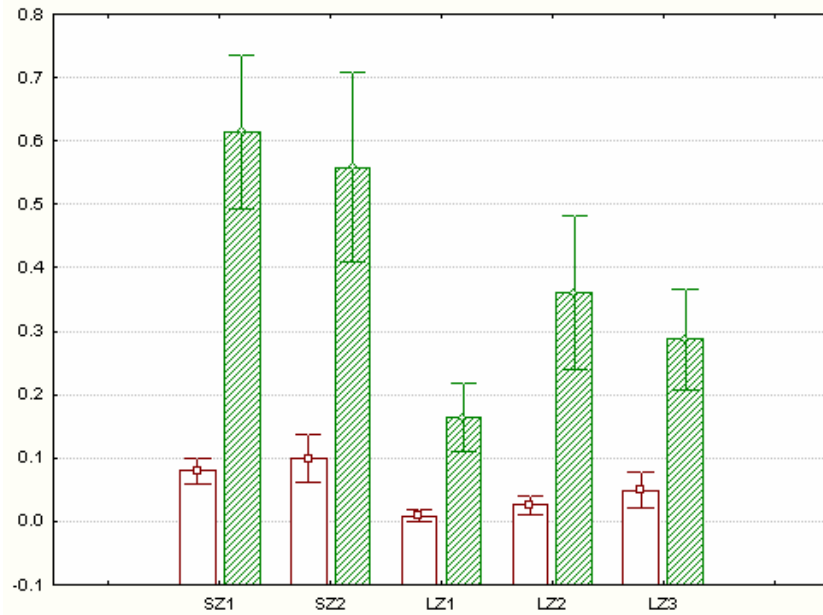

Figure 5b. Average number of *Fagus sylvatica* seedlings (10-20 cm) per quadrat according to light zones in small and large gaps in 2000 and in 2004. (For explanation see Figure 5a)

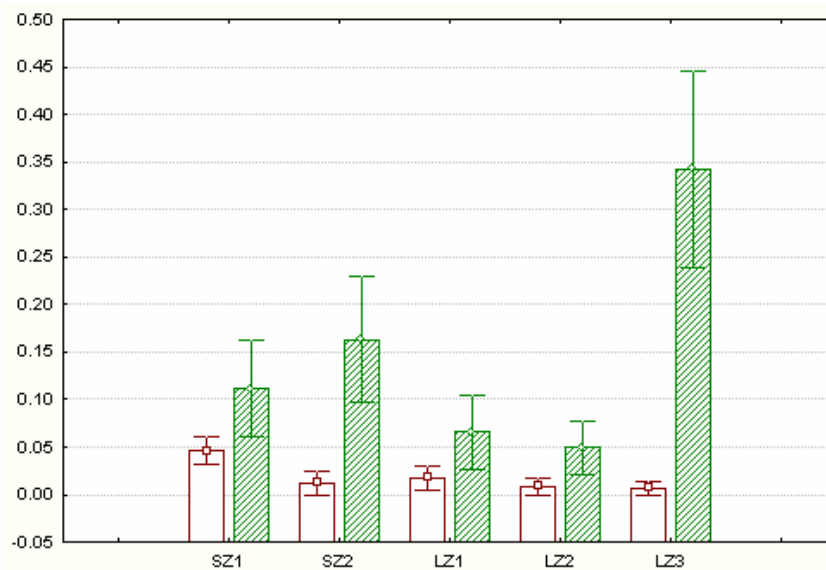

Figure 5c. Average number of *Fagus sylvatica* seedlings (20-50 cm) per quadrat according to light zones in small and large gaps in 2000 and in 2004. (For explanation see Figure 5a)

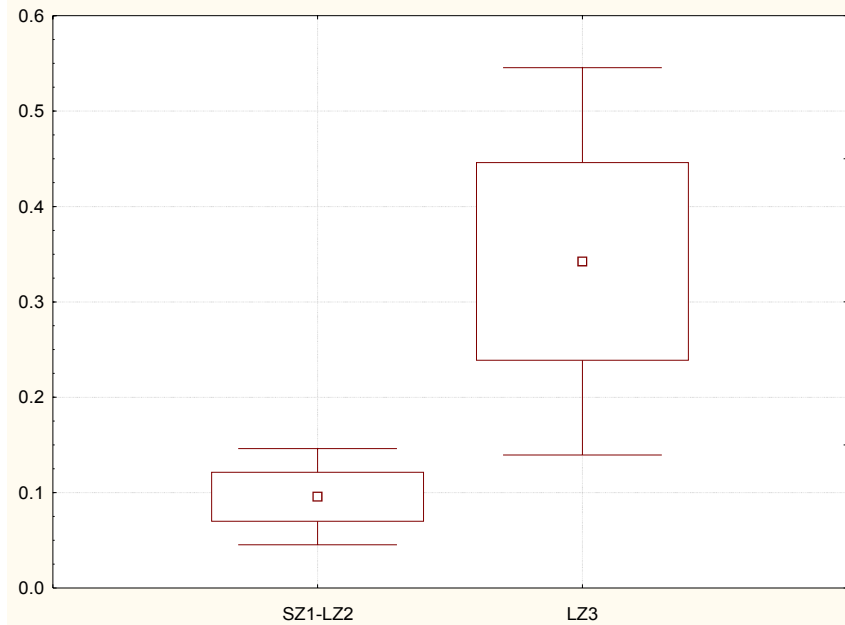

Figure 6. Average number of *Fagus sylvatica* saplings (20-50 cm) per quadrat in the Z1-Z2 and in Z3 light zone in 2004.

(Centre of the box represents mean, box represents $\pm 1 \cdot SE$, whisker represents $\pm 1.96 \cdot SE$, SZ1-LZ2: Light zone Z1 and Z2 in small and large gaps together, LZ3: Light zone Z3 in large gaps)

Salix caprea saplings occur only in gaps or at the edge of gaps regardless of gap size. They are most abundant in the centre of large gaps (Figure 7), while there is also a considerable amount in the centre of small gaps.

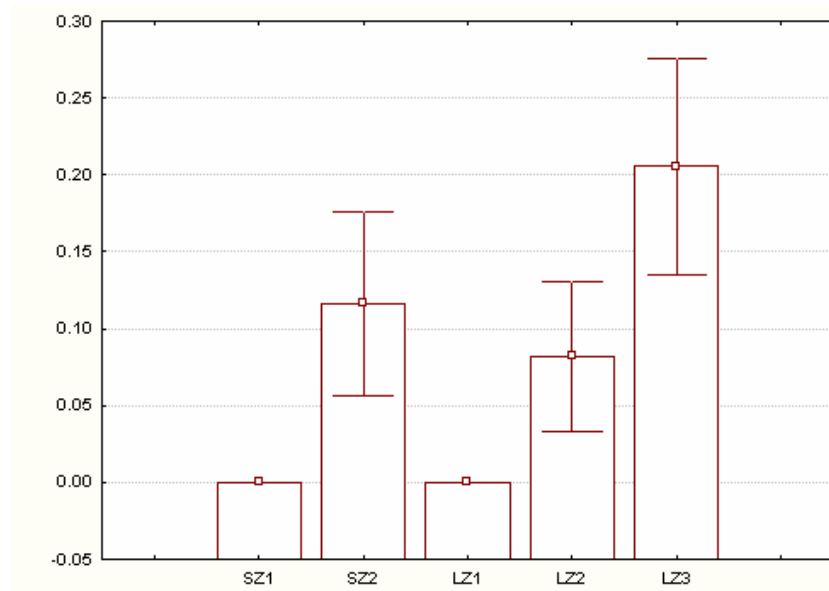

Figure 7. Average number of *Salix caprea* saplings per quadrat according to light zones in small and large gaps in 2004. (For explanation see Figure 5a)

According to results of *correlation* analysis (Spearman Rank Order Correlations) (Table 3) small beech seedlings show weak negative correlation with coarse woody debris (CWD) and positive correlation with percent cover of stone. Beech saplings between 10 and 20 cm show similar relationship with CWD and stone, furthermore weak negative correlation with percent of living canopy tree stems (tree) and diffuse light (DIF PACL). Larger *F. sylvatica* and *S. caprea* saplings are in positive correlation with total cover of herbaceous species (plantsum) and percent of intact soil. *Salix* also seems to have positive relationship with diffuse light.

Table 3. Results of correlation analysis between number of tree individuals and abiotic variables in 2004. (Explanation in the text.)

Seedling species and size (cm)	CWD (n=355)	stone (n=355)	tree (n=355)	intact soil (n=355)	plantsum (n=355)	DIF PACL (n=44)
F. sylv. < 10	R=-0.15***	R=0.15***				
F. sylv. 10-20	R=-0.15***	R=0.14***	R=-0.12**			R=-0.29**
F. sylv. 20-50			R=-0,11**	R=0,15***	R=0,20***	
S. capr.10-50			R=-0,11**	R=0,16***	R=0,31***	R=0,38**

In 2002 most *Salix caprea* saplings belonged to small size classes (<20 cm). Plots where *Salix* was present can be characterized by significantly (Mann-Whitney U Test, $p < 0.1$) lower percent of intact soil compared to those where *Salix* did not occur. On the contrary, in 2004 larger saplings (> 20cm) became dominant, *Salix* saplings were found especially in quadrats where intact soil is more characteristic (Figure 8).

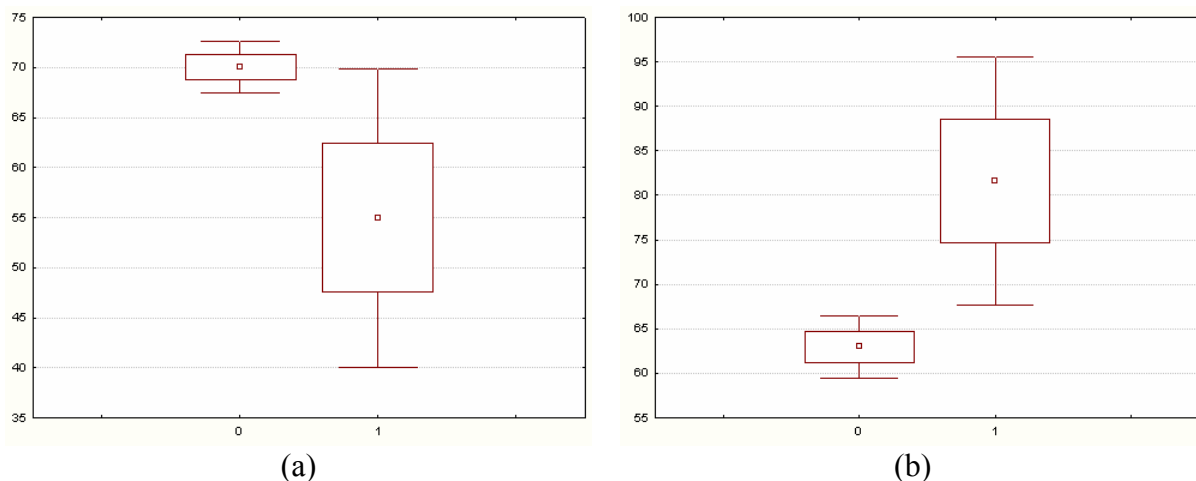

Figure 8. Percent of intact soil per quadrat according to the occurrence of *Salix caprea* saplings in 2002 (a) and in 2004 (b).

0: plots where *Salix* does not occur, 1: plots where *Salix* occurs,
Centre of the box represents mean, box represents $\pm 1 * SE$, whisker represents $\pm 2 * SE$

Each size class of *Fagus sylvatica* shows different distribution according to total cover of herbaceous species (Figure 9.) in 2004. Small seedlings (<10 cm) are most abundant at 20-40% of total cover, while amount of larger saplings (20-50 cm) increases with total cover and reaches maximum values at 60-80 %. Higher herbaceous cover does not seem to be preferred by seedlings and saplings. *Salix caprea* shows similar distribution as higher beech saplings (Figure 10).

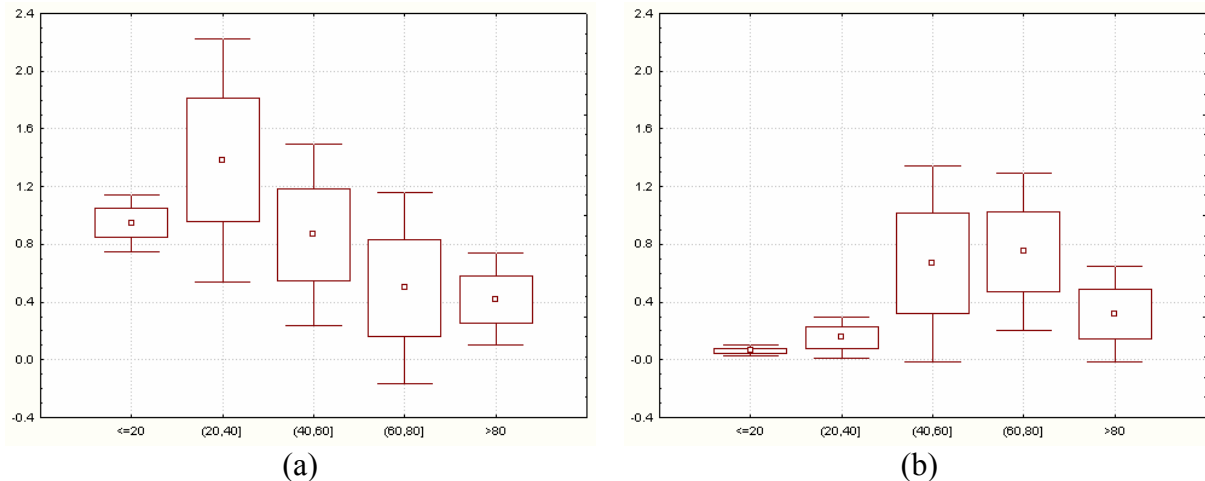

Figure 9. Average number of *Fagus sylvatica* saplings (0-10 cm (a); 20-50cm (b)) according to total cover of herbaceous species (*plantsum*) in 2004. (Signs as in figure 8)

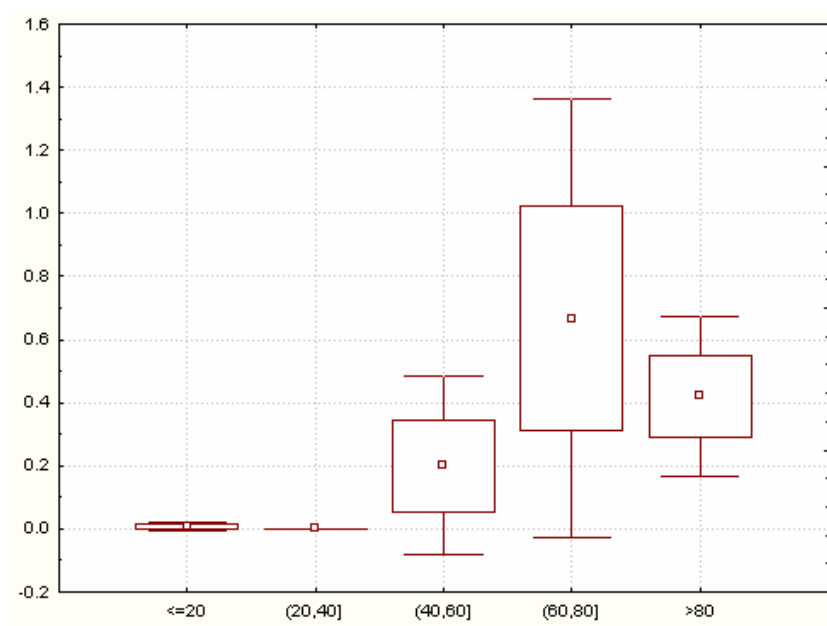

Figure 10. Average number of *Salix caprea* saplings according to total cover of herbaceous species (*plantsum*) in 2004. (Signs as in figure 8)

4 DISCUSSION

Our results show considerable overall increases in light levels in gaps. It is similar to previous studies in temperate forests that found that light quantity increases with opening size (Canham *et al* 1990 and references therein, Collins and Pickett 1987, 1988). It is necessary to emphasize that beside changes in light conditions, increase of soil water content is also a characteristic process after gap formation according to other studies (Collins *et al.* 1985, Minckler and Woerheide 1965, Pontailier 1979). Our other investigations also showed (Mihók *et al.* 2004) that the measured water content values in the gaps, at the edges of the

gaps and below the closed canopy are similarly different, regardless of the gap size. The increase of soil water content in gap centres may also have an essential effect on tree regeneration processes.

Preliminary results of our long-term investigations suggest, that opening of artificial gaps facilitated growth of newly established seedlings, beside advance regeneration that was present before gap creation. There was a mast year for beech in 2001, which increased the amount of regeneration mainly in two gaps in the following years.

While in the case of the small gaps there is no difference between in-gap and under-canopy position, average number of small beech seedlings is lower in the centre of large gaps than under canopy, which is explained by some authors (Peltier et al. 1997) as dispersal limitation. Larger beech saplings are more abundant in the centre of large gaps and *Salix*, as well, occurs more in central plots of large gaps. Occurrence of shade intolerant tree species with significant ability of dispersal in centres of large gaps is reported from different forest types (Lawton 1990).

Our results show that the establishment of *Fagus* seedlings is quite insensitive to environmental conditions. Germination is not influenced by light, – where seed dispersal is effective, i.e. in smaller gaps – the probability of establishment of *Fagus* seedlings is the same in gaps and under canopy (Muys et al. 1988, Hahn 2000). Success of establishment depends more on soil moisture than on light conditions (Fanta 1995). Large amount of coarse woody debris, however, seems to make establishment difficult. Dense slash and stems may inhibit seeds to reach ground surface leading to high seed mortality. Stones, however, may provide appropriate refugia for seeds against seed predators, but further investigations would be necessary to make this relationship clear.

On the contrary, older *Fagus* saplings showed positive relationship with increasing herbaceous cover. Taller saplings were present mainly in the center of large gaps. Higher herbaceous abundance is due to increased incident light – and other factors e.g. soil water content. Though larger saplings did not show significant correlation with relative light intensity according to our results, other studies (Peltier et al. 1997) indicate that light is very important factor for sapling development, enhancing especially root development. In poor light conditions, seedlings are more susceptible to drought (Topoliantz and Ponge 2000). We suggest that the result – larger saplings occur in centre of large gaps, where herbaceous cover is dense – can also be related to game damage. In the dense herb layer developing in gaps, herbivores may not find every seedling, so saplings may survive with bigger chance – this effect may be in trade off with the competitive pressure of increasing herb cover. This finding is supported by other studies focusing on the effect of density and height of neighbouring vegetation on tree sapling susceptibility (Miller et al. 1982, Gill 1992, Rao et al. 2003, Pietrzykowski et al. 2003 and references therein, Kuiters and Slim 2003). Further investigations would help to get a better understanding of gap regeneration processes and its applicability in forestry practice.

Acknowledgments: We would like to thank János Ruff and the Ipoly Erdő Co. for supporting the research, Kata Kenderes, Andrea Hagyó for helping in data collection. The project was financially supported by NAT-MAN: Nature-based management of beech in Europe (Fifth Framework Programme, Contract No.: *QLK5-1999-01349*; <http://www.flec.kvl.dk/natman/>). Further support was provided by the Hungarian Academy of Sciences.

REFERENCES

- BROKAW, N. – BUSING, R.T. (2000): Niche versus chance and tree diversity in forest gaps. *Trends in Ecology and Evolution* 15: 183-188.
- BRUNNER, A. (2000): Hemispherical photography and image analysis with hemIMAGE and Adobe® Photoshop® 3.0 (manual)
- BUSING, R.T. – WHITE P.S. (1997): Species diversity and small-scale disturbance in an old-growth temperate forest: a consideration of gap-partitioning concepts. *Oikos* 78: 562-568.
- CANHAM, C.D. (1989): Different responses to gaps among shade tolerant tree species. *Ecology* 70: 548-550.
- CANHAM, C.D. – DENSLOW, J.S. – PLATT, W.J. – RUNKLE, J.R. – SPIES, T.A. – WHITE, P.S. (1990): Light regimes beneath closed canopies and tree-fall gaps in temperate and tropical forests. *Canadian Journal of Forest Research* 20: 620-631.
- COLLINS, B.S. – PICKETT, S.T.A. (1987): Influence of canopy opening on the environment and herb-layer in a northern hardwoods forest. *Vegetatio* 70: 3-10.
- COLLINS, B.S. – PICKETT, S.T.A. (1988): Demographic responses of herb layer species to experimental canopy gaps in a northern hardwoods forest. *Journal of Ecology* 76: 437-450.
- COLLINS, B.S. – DUNNE, K.P. – PICKETT, S.T.A. (1985): Responses of forest herbs to canopy gaps. In: Pickett S.T.A. – White P.S. (eds.). *The Ecology of Natural Disturbance and Patch Dynamics*, Academic Press, INC., Orlando, Florida.
- DENSLOW, J.S. – SPIES, T. (1990): Canopy gaps in forest ecosystems: an introduction. *Canadian Journal of Forest Research* 20: 619.
- FANTA, J. (1995): Beuk (*Fagus sylvatica* L.) in het Nederlandse deel van het NW-Europees diluvium. *Nederlands Bosbouw Tijdschrift* 67, 225-0234.
- GAYER, H. (1895) *Der Femelschlagbetrieb und seine Ausgestaltung in Bayern*. Cit. in: Roth, Gy. (1935): *Erdműveléstan [Silviculture]II*. Röttig-Romwalter, Sopron. 526-529 (in Hungarian)
- GILL, R.M.A. (1992): A review of damage by mammals in north temperate forests. I. Deer. *Forestry* 65: 145-169.
- GRAY, A.N. – SPIES, T.A. (1996): Gap size, within gap position and canopy structure effects on conifer seedling establishment. *Journal of Ecology* 84: 635-645.
- GRAY, A.N. – SPIES, T.A. (1997): Microsite controls on tree seedling establishment in conifer forest canopy gaps. *Ecology* 78 (8): 2458-2473.
- HAHN, K. (2000): Development of natural regeneration and flora in gaps in three deciduous forests in Denmark. Master thesis. The Royal Veterinary and Agricultural University Unit of Forestry, Denmark.
- HILHORST, M.A. (1998): Dielectric characterisation of soil. Doctoral Thesis. Wageningen Agric. Univ. 69-71.
- HOLEKSA, J. (2003): Relationship between field-layer vegetation and canopy openings in a carpathian subalpine spruce forest. *Plant Ecology* 168: 57- 67.
- KUITERS, A.T. – SLIM, P.A. (2003) Tree colonisation of abandoned arable land after 27 years of horse-grazing: the role of bramble as a facilitator of oak wood regeneration. *For. Ecol. Manage.* 181: 239–251.
- KWIT, C. – PLATT, W.J. (2003): Disturbance history influences regeneration of non-pioneer understory trees. *Ecology* 84 (10): 2575-2581.
- LAWTON, R.O. (1990): Canopy gaps and light penetration into a wind-exposed tropical lower montane rain forest. *Canadian Journal of Forest Research* 20: 659-667.
- MIHÓK, B. – GÁLHIDY, L. – HAGYÓ, A. – STANDOVÁR, T. – RAJKAI, K. (2004): Comparative studies of gap-phase regeneration in managed and natural beech forests in different parts of Europe: relations between tree regeneration and light, soil conditions, and ground vegetation. Part 5 - Case study partner report from Hungary. NatMan project WP3. Working Report 37. Deliverable 12 and 21.
- MILLER, G.R. – KINNIARD, J.W. – CUMMINS, R.P. (1982): Liability of saplings to browsing on a red deer range in the Scottish Highlands. *Journal of Applied Ecology* 198: 941-951.

- MINCKLER, L.S. – WOERHEIDE, J.D. (1965). Reproduction of hardwoods 10 years after cutting as affected by site and opening size. *Journal of Forestry* 63: 103-107.
- MUYS, B. – van der BERGE, K. – ROSKAMS, P. – MADELEIN, D. – Meyen, S. (1988): Analysis of natural regeneration in a 200 years old beech stand. *Silva Gandavensis* 53: 61-81.
- NAKASHIZUKA, T. (1985): Diffused light conditions in canopy gaps in a beech (*Fagus crenata* Blume) forest. *Oecologia* 66: 472-474.
- PELTIER, A. – TOUZAND, M.-C. – ARMENGAUD, C. – PONGE, J.-F. (1997): Establishment of *Fagus sylvatica* and *Fraxinus excelsior* in an old-growth beech forest. *Journal of Vegetation Science* 8: 13-20.
- PETERKEN, G.F. (1996): *Natural Woodland. Ecology and conservation in Northern Temperate Regions.* University Press, Cambridge. 91-107.
- PIETRZYKOWSKI, E. – MCARTHUR, C. – FITZGERALD, H. – GOODWIN, A.N. (2003): Influence of patch characteristics on browsing of tree seedlings by mammalian herbivores. *Journal of Applied Ecology* 40 (3): 458-469.
- PLATT, W.J. – STRONG D.R. (1989): Gaps in forest ecology. *Ecology* 70 (3): 535.
- PONTAILLER, J. Y. (1979): La regeneration du hetre en foret de fontainbleau, ses relations avec les conditions hydriques statinnelles. PhD. Thesis, Univ. Paris, Sud, Cent. DOrsay.
- POULSON, T.L. – PLATT, W.J. (1989): Gap light regimes influence canopy tree diversity. *Ecology* 70(3): 553-555.
- RAO, S. J. – IASON, G.R. – HULBERT, I.A.R. – ELSTON, D.A. – RACEY, P.A. (2003): The effect of sapling density, heather height and season on browsing by mountain hares on birch. *Journal of Applied Ecology* 404: 626 –638.
- ROTH, GY. (1935): Erdőműveléstan [Silviculture] II. Röttig-Romwalter, Sopron. 522-535 (in Hungarian)
- RUNKLE, J.R. (1989): Synchrony of regeneration, gaps, and latitudinal differences in trespecies diversity. *Ecology* 70: 546-547.
- SOMOGYI, Z. (1998): A bolygatások jelensége, szerepe az erdő ökoszisztémában és erdőművelési jelentősége. [Occurrence and role of disturbance in forest ecosystems and its importance for silviculture.] *Erdészeti Kutatások* 88: 165-194. (in Hungarian)
- TOPOLIANTZ, S. – PONGE, J-F (2000): Influence of site condition on the survival and growth of *Fagus sylvatica* seedlings in an old-growth beech forest. *Journal of Vegetation Science* 11: 396-374.
- VITOUSEK, P.M. – DENSLOW, J.S.(1986): Nitrogen and phosphorus availability in treefall gaps of a lowland tropical rainforest. *Journal of Ecology* 74: 1167-1178.

Genetic Analysis of Swiss Stone Pine Populations (*Pinus cembra* L. subsp. *cembra*) from the Carpathians Using Chloroplast Microsatellites

Mária HÖHN^{a*} – Péter ÁBRÁN^b – Giovanni Giuseppe VENDRAMIN^c

^a Department of Botany, Faculty of Horticultural Science, Corvinus University Budapest, Hungary

^b Agency of Environmental Protection, District Mures, Targu Mures, Romania

^c Institute of Plant Genetics, Division of Florence, CNR, Sesto Fiorentino, Firenze, Italy

Abstract – The diversity of Swiss stone pine populations (*Pinus cembra* subsp. *cembra*) native to the Carpathians was studied with chloroplast microsatellite markers (cpSSR). Six loci were analyzed in four populations (altogether 148 individuals) and a total number of 22 size variants and 41 combinations referred to as haplotypes were detected. Diversity within populations was found to be high, whereas divergence between the populations was low ($F_{st} = 0.02$). The most variable population with the highest haplotype diversity ($H = 0.956$) originated from the Retezat Mountains (South Carpathians). Multi-stemmed individuals were detected mainly in the Southern part of the Calimani Mountains. They were found to be genetically non-homogenous. It is assumed that these clusters of individuals are the result of plants emerging from seed caches by birds. The great haplotypic variation found in cpSSR loci makes all the populations a useful source for gene conservation purposes. Each population should be considered an important element of the local ecosystem diversity.

chloroplast DNA microsatellites / size variants / haplotypic diversity

Kivonat – Genetikai diverzitás vizsgálatok a Kárpátok cirbolyafenyő (*Pinus cembra* L. subsp. *cembra*) populációiban kloroplasztisz mikroszatellit markerek felhasználásával. A tanulmányban az európai cirbolya (*Pinus cembra* subsp. *cembra*), Kárpátokban élő, populációinak diverzitását vizsgáltuk kloroplasztisz DNS mikroszatellit markerekkel (cpSSR). 6 SSR lokusz analízisa során négy populációban összesen 21 méret variánst és 41 kombinációt, azaz haplotípust, mutattunk ki (148 egyed). Minden populáció diverzitása magas volt, de a populációk közötti divergencia mértéke alacsonynak bizonyult ($F_{st} = 0,02$). A legnagyobb haplotípus variabilitást a Retyezát havasok populációjában tapasztaltuk, ($H = 0,956$). Iker- és soktörzsű egyedek vizsgálata során kimutattuk, hogy a kéttörzsű egyedek többsége eltérő genotípusú volt. Ezek vélhetően a madarak táplálék raktározó készletéből és együttes csírázásából származtak. A legtöbb ilyen egyed a Kelemen havasok déli állományában találtuk. A populációk nagy genetikai variabilitása felhívja a figyelmet arra, hogy minden egyes állomány a faj fontos génkészletét képezi, ezért minden kis populáció fokozott védelmét biztosítani kell. A cirbolyafenyő mint jégkorszaki reliktum csakis így módon maradhat a montán ökoszisztémák diverzitásának meghatározó eleme.

kloroplasztisz DNS mikroszatellit / méret variáns / haplotípus diverzitás

* Corresponding author: maria.hohn@uni-corvinus.hu; H-1118 BUDAPEST, Ménesi út 44.

1 INTRODUCTION

Swiss stone pine (*Pinus cembra* subsp. *cembra*) is considered to be a glacial relict living in European high mountains, surviving at the timberline and in subalpine forest habitats of the Alps and the Carpathians. The biogeographic distribution of the remaining populations is due to the retreat of individuals in response to the changes of the macroclimate, to the availability of suitable habitats (and some other aspects, in particular to competitive exclusion). Climatic and environmental conditions during the full-glacial facilitated the dispersal of *Pinus* species, including *Pinus cembra*, within Central Europe (Willis et al. 1998). Macroscopic charcoal evidence linked with molluscan paleofauna study supports the presence of *Pinus cembra* even at low elevations of the Carpathian basin (Willis et al. 2000). The wide distribution was interrupted by the global warming of the Holocene when broad scale vegetation changes occurred and this resulted in the withdrawal of pines, including Swiss stone pine, that has retreated to higher elevations. Because of missing macrofossil data, it is hardly possible to resolve the postglacial history of this species. However, some palynological records of the Calimani mountains (Eastern Carpathians) provide evidence for a sporadic occurrence of *Pinus cembra* in the high mountain area since the Boreal-Atlantic age (8000-5000yr. B.P.; Farcas et al. 1999, 2000). It seems that this species suffered a sharp reduction of its range, and population sizes decreased markedly during the postglacial period. Presumably, isolation by distance that largely or completely inhibited gene flow, had some effects on the population structure of the species. However, at the species level, drift in single fragmented populations may even increase among-population variance (Mátyás 2004).

The present genetic structure of the species stands is influenced by the gene-flow patterns (Richardson et al. 2002). In case of whitebark pine (*Pinus albicaulis*) and in stone pine species in general, gene flow is determined by wind-dispersed pollen and by seed dispersed by nutcrackers (*Nucifraga* spp.). The multi-stemmed growth form is attributed to multiple germination of seed caches set up by birds (Linhart – Tomback 1985, Turcek 1961). Thus birds play a crucial role in the natural reproduction and distribution of the stone pine species in Eurasia and North America.

The population genetic structure of Eurasian stone pine species including Swiss stone pine was studied by Goncharenko et al. (1992). Isozyme studies revealed generally high genetic variability in case of all pine populations of the subsection *Cembrae*, but low genetic differentiation between populations. These facts are supported also by the results of Krutovskii et al. (1995). They found that these species have F_{st} values ranging between 0,02–0,04. While in each study authors included just one population of *P. cembra* – considered peripheral – from the Carpathians (West-Ukraine), they could not characterize the variability level of the Carpathian populations in general. The genetic variability of eleven Swiss stone pine populations was investigated by Szmídt (1982). Based on allozyme frequencies and average heterozygosity, genetic diversity was found to be low within populations, while genetic divergence between populations was considered higher than that calculated for other conifers. He found that the Romanian population from the Retezat Mts., included also in the present study, was the second most outstanding population with regard to its genetic diversity.

To evaluate the present genetic structure of the protected relic populations as well as to characterise diversity patterns of the populations native to different regions of the Carpathians we studied cpDNA microsatellite (cpSSR) haplotype variability of *Pinus cembra* subsp. *cembra*. Paternally inherited cpDNA SSR markers with high levels of variability have proved to be valuable for detecting genetic structure of populations in many conifer species (Echt et al. 1998, Vendramin et al. 1998). Three from the primer pairs designed by Vendramin et al. (1996) for *Pinus thunbergii* have already been applied successfully for species belonging to subsection *Cembrae* of the section *Strobus* (Gugerli et al. 2001). While populations of the

Alps have already been included in molecular studies, evaluation of those occurring in the Carpathians would extend the knowledge about this regionally endangered species.

2 MATERIAL AND METHODS

2.1 Sampling

148 individuals of four stands belonging to three geographically distinct regions of the Carpathians were analysed (*Table 1*). The distance between the first two populations is less than 20 km, therefore gene flow was between them presumed. Leaf material was collected from individuals that were at least 30 m apart. Exceptions were multistemmed or clusters of young individuals attributed to the germination out of seed caches. These clusters were found mainly in the South Calimani Mts.

Table 1. Location of sampled populations

Abbrev.	Population location	Region	Latitude N	Longitude E	No. of samples
Cal-Suc.	Mt. Calimani-North District Suceava	Eastern Carpathians	47° 14'	25° 20'	57
Cal-Mur.	Mt. Calimani-South District Mures	Eastern Carpathians	46° 57'	25° 06'	57
Ret.	Mt. Retezat District Hunedoara	Southern Carpathians	45° 32'	22° 57'	24
Tatra	Mt. Solisko District Prešov	Tatra Mts.	49° 07'	20° 04'	10

2.2 DNA extraction and PCR reaction

Genomic DNA was extracted from leaf material dried on silica gel, following the Qiagen Plant Mini kit protocol.

Six mononucleotide microsatellite loci (SSR) from the chloroplast DNA (Pt36480, Pt26081, Pt63718, Pt 30204, Pt87268, Pt15169) were screened for length variation. PCR amplifications were performed according to Vendramin et al. (1996) using a Perkin Elmer 9600 thermal cycler with the following profile: 5 min. at 95 °C, 5 min at 80 °C, 25 cycles of 1 min. at 94 °C, 1 min. at 55 °C, 1 min. at 72 °C, with a final extension step at 72 °C for 8 min. The success of the amplification was tested on a 1.4% agarose gel.

2.3 Fragment analysis

Amplified fragments were multiplexed by size. Two or three fragments of different size ranges were pooled and loaded along with internal size standards (50, 100, 150, 200 bp), and external standards were used. Size detection was performed on an Alf Express Fragment Analyser (Amersham) using Reprogel Long Read acrylamide gel. Each run contained a control individual. Fragments that differed in size by 1 bp could be reliably distinguished and assigned to different categories for the same samples run on different gels. Results were analysed with Fragment Manager 1.2 (Amersham). Several samples were run twice to increase the accuracy.

2.4 Statistical analysis

Haplotypic diversity, estimated by $H = (n/n-1)(1-\sum p_i^2)$, where p refers to the haplotype frequencies, and n to the number of individuals per population (Nei 1987), effective number of haplotypes was estimated by $n_e = 1/\sum p_i^2$, frequency of the most common haplotype and number of different size variants were calculated (Table 3). Partitioning of molecular variance and also fixation indices (F_{st}) were estimated by an analysis of molecular variance (AMOVA). Comparison of pairs of population samples were conducted using the genetic distance approach based on haplotype frequency under the infinite allele model (IAM), as well as using the stepwise mutation model (SMM) (Slatkin 1995) in a second approach. These procedures were performed using Arlequin software (v. 2.0; Schneider et al. 2000).

3 RESULTS

Five out of six cpSSR loci analysed were polymorphic, giving a total of 22 different size variants. The distribution of the size variants in the studied populations is presented in Figure 1. Rare variants were present mainly in the Retezat Mts. as well as in the Calimani-Suceava population.

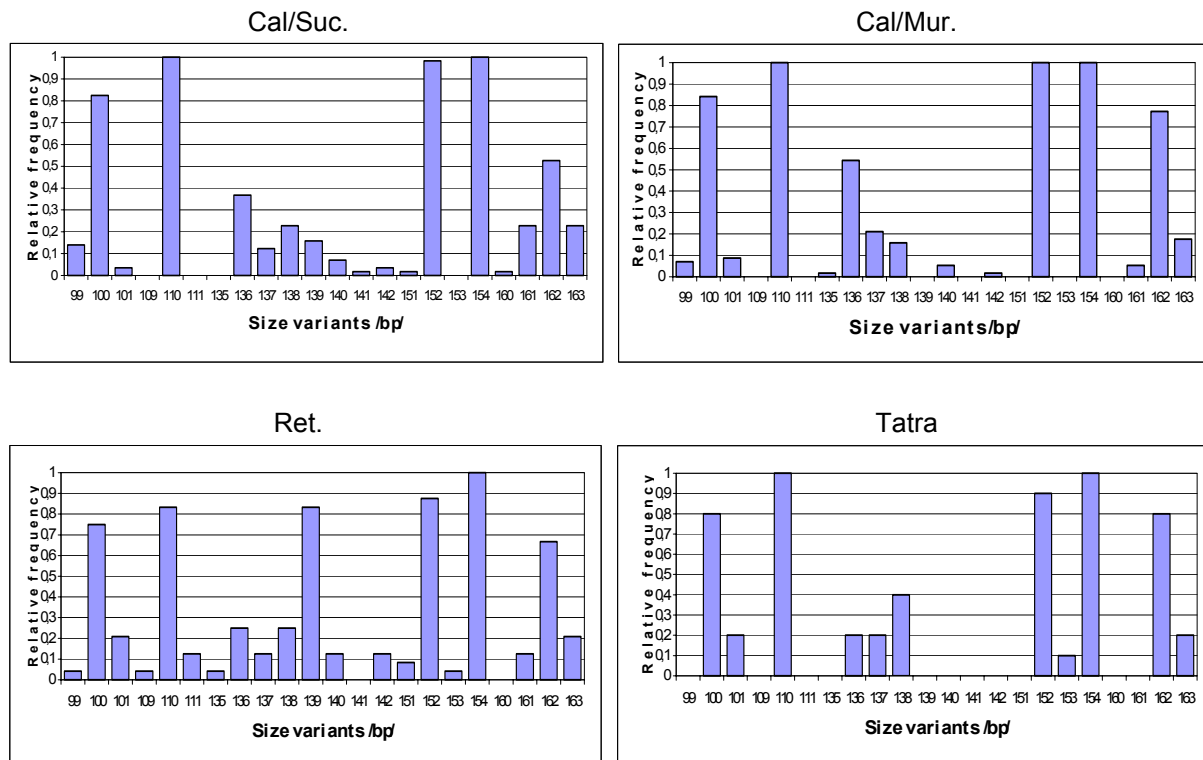

Figure 1. Distribution of size variants in the studied populations: locus 1 (3 size variants), locus 2 (3 size variants), locus 3 (8 size variants), locus 4 (3 size variants), locus 5 (1 size variant), locus 6 (4 variants)

The most variable locus was Pt15169, having altogether eight variants, followed by Pt30204 with four size variants. We detected 41 different combinations of size variants i.e. haplotypes. No significant correlation was found between the number of size variants and population size. There was also no significant correlation between the number of haplotypes and the population sample size. Frequency and distribution of haplotypes are reported in Table 2.

Table 2. Frequency and distribution of haplotypes in the four studied populations

Haplotype label	Cal-Suc.	Cal-Mur.	Ret.	Tatra	Average	Private haplotype for populations
1	0.018	0.018	0.042	0	0.020	
2	0.035	0	0	0	0.014	Cal-Suc.
3	0.053	0	0.042	0	0.027	
4	0.018	0	0	0	0.007	Cal-Suc.
5	0.053	0	0	0	0.020	Cal-Suc.
6	0.053	0	0.058	0	0.034	
7	0.105	0.123	0	0.200	0.101	
8	0.018	0	0	0	0.007	Cal-Suc.
9	0.018	0	0	0	0.007	Cal-Suc.
10	0.193	0.351	0.167	0.100	0.243	
11	0.018	0	0	0	0.007	Cal-Suc.
12	0.070	0.018	0	0	0.034	
13	0.035	0.018	0	0	0.020	
14	0.035	0.175	0.083	0.200	0.108	
15	0.018	0.105	0.042	0	0.014	
16	0.035	0.018	0	0	0.020	
17	0.018	0	0	0	0.007	Cal-Suc.
18	0.035	0	0.042	0	0.020	
19	0.035	0.053	0.042	0	0.041	
20	0.018	0	0	0	0.007	Cal-Suc.
21	0.070	0	0	0	0.068	Cal-Suc.
22	0.018	0	0	0	0.007	Cal-Suc.
23	0.018	0.018	0	0	0.014	
24	0.018	0	0.125	0	0.027	
25	0	0.018	0	0.100	0.014	
26	0	0.018	0	0	0.007	Cal-Mur.
27	0	0.018	0	0	0.007	Cal-Mur.
28	0	0.018	0	0	0.007	Cal-Mur.
29	0	0.018	0	0	0.007	Cal-Mur.
30	0	0.018	0	0	0.007	Cal-Mur.
31	0	0	0.042	0	0.007	Ret.
32	0	0	0.042	0	0.007	Ret.
33	0	0	0.042	0	0.007	Ret.
34	0	0	0.042	0	0.007	Ret.
35	0	0	0.042	0	0.007	Ret.
36	0	0	0.083	0	0.014	Ret.
37	0	0	0.042	0	0.007	Ret.
38	0	0	0	0.100	0.007	Tatra
39	0	0	0	0.100	0.007	Tatra
40	0	0	0	0.100	0.007	Tatra
41	0	0	0	0.100	0.007	Tatra
Count	24	16	16	8	41	

To summarize, haplotype no.10 was the most frequent (0.243) with a high dominance in each population. 36.6% (15) of the haplotypes were common in the populations, while the remaining 63.4 % (26) – considered as private haplotypes – only occurred in one population.

The private haplotypes were represented by low frequency values, ranging between 0.018–0.1. No pairs of populations were composed of the same haplotypes. The number of private haplotypes were highest in Calimani-Suceava and Retezat, 10 (41.66%), and 7 (43.79%), respectively.

Gene diversity (unbiased haplotypic diversity), was high in all populations, with a mean value of 0.917. Most of the H values ranged above 0.90 except for Calimani-Mures (*Table 3*).

Table 3. Measures of cpSSR variation within populations

Population label	No of samples	No of size variants	Effective no. of haplotypes (n_e)	Frequency of the most common haplotype (f_a)	Haplotypic diversity (H)
Cal-Suc.	57	18	12.94	0.192	0.939
Cal-Mur.	57	15	5.14	0.350	0.819
Ret.	24	20	12.02	0.166	0.956
Tatra	10	13	7.14	0.100	0.955
Mean		16.5	9.31	0.20	0.917

Indicated by all genetic parameters, this population had the lowest within-population diversity. Taking all parameters into account, the most variable and divergent population was that of the Retezat Mts. The extremely high within-population variability of Retezat Mts. may be one of the reasons for the genetic differentiation of this population based on isozyme, analysis reported by Szmidt (1982). The second most variable population was the Tatra population, followed by that from the Calimani-Suceava, genetic parameters being close to those of the Retezat Mts.

AMOVA confirmed low genetic differentiation between populations (*Table 4*). Genetic divergence based on F_{st} as well as R_{st} (not shown) estimates shows low values, ($F_{st} = 0.02$).

Table 4. AMOVA results according to genetic distance, F_{st}

Source of variation	d.f.	Sum of squares	Variance components	Percentage of variation
Among populations	3	4.854.8	0.02367	2.76
Within populations	144	119.923	0.83280	97.24
Total	147	124.777	0.85647	
Fixation index	$F_{st} = 0,0276$			

Pairwise comparison of populations according to genetic distances are presented in *Table 5*.

Table 5. Pairwise F_{st} (below the diagonal) and R_{st} (above the diagonal) values

Population label	Cal-Suc	Cal-Mur	Ret.	Tatra
Cal-Suc		0.098 +	0.008	0
Cal-Mur	0.037 +		0.196 +	0.123
Ret.	0.015	0.043 +		
Tatra	0.016	0.026	0	

Significance shown: “+” (significance level: 0,05)

Based on pairwise F_{st} (IAM) as well as on pairwise R_{st} (SMM), significant differences were detected between the populations of the Calimani-Mures and Retezat, as well as between the two sites of the Calimani Mountains. Although genetic differentiation resulted in higher values between the populations of Calimani-Mures and Retezat, the non-significant differentiation between Calimani-Suceava and Retezat suggests that no discernible correlation

exists between genetic and geographical distance. Pairwise estimation produced negative values for the Tatra. These values are not interpretable, are considered to be zero.

3.1 Multi-stemmed individuals

During material collection multi-stemmed individuals were detected in populations of the Calimani Mts., three in the south (Calimani-Mures), and one in the north (Calimani-Suceava). A group of cluster-forming individuals probably of same age was also studied (Table 6). All of them were growing on rocky surface. Three twin-stemmed out of four multi-stemmed growing individuals were genetically different. Among cluster forming individuals, one was genetically different.

Table 6. Haplotypes of twin-stemmed growing and cluster forming individuals

Label of pairs of individuals	Haplotype	Population
51/51a	152/110/100/161/154/139	Cal-Suc.
	152/110/100/161/154/140	
17/18	152/110/100/162/154/136	Cal-Mur.
	152/110/100/162/154/136	
2/3	152/110/100/162/154/136	Cal-Mur
	152/110/100/162/154/138	
12/13	152/110/100/162/154/137	Cal-Mur.
	152/110/100/162/154/139	
Cluster of 7/8/9/10	152/110/100/162/154/136	Cal-Mur.
	152/110/100/162/154/138	
	152/110/100/162/154/136	
	152/110/100/162/154/136	

4 DISCUSSION

In this investigation haplotypic diversity of populations of the Carpathians has been studied. CpSSR markers revealed large polymorphism within populations. The five polymorphic loci analyzed in this study indicated a high variability level, resulting in a great number of haplotypes within each population. Private haplotypes of the populations were also detected. The low frequency of private haplotypes and the higher frequency values of the common haplotypes resulted in low differentiation between populations ($F_{st} = 0.02$). These values are similar to the results obtained based on isozyme studies carried out by Krutovskii et al. (1995) in case of other stone pine species. However, these authors analyzed just one Carpathian population: our results seem to confirm their supposition that populations along the range of *Pinus cembra* in the Carpathians have generally high variability. The comparatively low genetic variability of the population in the Southern Calimani (Calimani-Mures) may be explained by the low number and scattered occurrence of individuals clustering predominantly on rocky surfaces. Private haplotypes which were detected in old individuals of more than 200 years of age, growing in narrow deep valleys, provide evidence for a once existing large population in this area forming for a wide, continuous distribution of stone pine in the Calimani Mts. This was supported also by palynological records that ascertain the species' presence in increasing quantity from 'Picea-Quercus mixture pollen horizon' of the Atlantic age, up to the surface (Farcas 1999). However, nutcrackers counterbalance the drastic decrease in the population size along the southern part, providing permanent seed

supply even from the north. Multi-stemmed clusters of individuals found genetically not identical represent an important aspect of the population diversity.

Pairwise genetic differentiation of the populations resulted in low values even between geographically distant populations. Species with a scattered range, such as *Pinus cembra*, are expected to show low within-population genetic diversity due to genetic drift and limited gene flow. In these populations isolation following the withdrawal of species range in the Holocene did not produce inbreeding that would appear in genetic structure. Possible reasons can be attributed to the longevity of stone pine, to the effective selection mechanism eliminating inbred embryos and individuals, and/or the possibility of gene flow between populations (wind dispersed pollen and animal mediated seed transfer). Even if gene flow does not occur in present, the genetic pattern reflects processes of the recent past up to few thousand years ago when stone pine was probably more widely distributed in the upper mountain zone. Due to postglacial climate conditions, natural competition between spruce and stone pine was decisive in favour of spruce dominance, and since then stone pine has retreated to marginal habitats. Presumably, natural processes were accelerated also by human activities in the last centuries. Clear-cut or burned areas in the mountain forest regions were naturally regenerated by spruce and not colonized by stone pine being already at the edge of its ecological tolerance. Such conditions seem to occur in the southern part of the Calimani Mts.

Because of the limited number of populations available in this study, results and conclusions have to be taken with caution. More extensive investigations covering additional populations should be made in the future to prove whether the genetic structure described above is proper for the whole distribution range of *Pinus cembra* in the Carpathians.

The large haplotypic variation found in cpSSR loci renders all populations a useful source for gene conservation purposes. Each scattered small population should be considered a proper genetic resource of the species and an important element of the local ecosystem diversity, which may justify the species' protection. There is a compelling claim for protection of all those habitats that are strongly influenced by human activities, resulting in extensive fragmentation of the distribution which has been already profoundly shaped previously by biogeographical events.

Acknowledgements: We are grateful to Csaba Mátyás and Felix Gugerli for useful comments and remarks. Special thanks to Anna Papp-Bacsikai for assistance, Tibor Baranec, László Udvardy, Márta Bényei-Himmer, Géza Facsar for providing plant material from the Tatra, Antal Ferenczi and Tamás Deák for statistical advice. This project was partly funded by OTKA grant no.T037703.

REFERENCES

- ECHT, C.S. – DEVERNO, L.L. – ANZIDEI, M. – VENDRAMIN, G.G. (1998): Chloroplast microsatellites reveal population genetic diversity in red pine, *Pinus resinosa* Ait. *Mol. Ecol.* 7: 307-316.
- FARCAS, S. – TANTAU, I. (1999): Analyse palynologique du profil tourbeux „Intre Afini”(Monts Calimani). *Acta Palaeontologica Romaniae* 2: 157-162.
- FARCAS, S. – TANTAU, I. – BODNARIUC, A. (1999-2000): Aspects de l'histoire de la végétation des Monts Calimani, reflétée dans les analyses palynologiques effectuées a Poiana Puturosul. *Contrib. Bot. Gradina Botanica, Cluj-Napoca.* I: 177-185.
- TURCEK, J. F. (1961): *Ökologische Beziehungen der Vögel und Gehölze.* Bratislava

- GONCHARENKO, G.G. – PADUTOV, V.E. – SILIN, A. (1992): Population structure, gene diversity, and population differentiation in natural populations of Cedar pines (*Pinus* subsect. *Cembrae*, Pinaceae) in the USSR. *Plant Syst. Evol.* 182: 121-134.
- GUGERLI, F. – SENN, J. – ANZIDEI, M. – MADAGHIELE, A. – BÜCHLER, U. – SPERISEN, C. – VENDRAMIN, G.G. (2001): Chloroplast microsatellites and mitochondrial *nad1* intron 2 sequences indicate congruent phylogenetic relationships of Swiss stone pine (*Pinus cembra*), Siberian stone pine (*Pinus sibirica*) and Siberian dwarf pine (*P. pumila*). *Mol. Ecol.* 10: 1489-1497.
- KRUTOVSKII, K.V. – POLITOV, D.V. – ALTUKHOV, Y.P. (1995): Isozyme study of population genetic structure, mating system and phylogenetic relationships of the five stone-pine species (Subsection *Cembrae*, Section *Strobus*,). In: Baradat P. – Adams, W.T. – Müller-Starck, G. (eds.): *Population Genetics and Genetic Conservation of Forest Trees.* 279-304.
- LINHART, Y.B. – TOMBACK, D.F. (1985): Seed dispersal by nutcrackers causes multi-trunk growth form in pines. *Oecologia* 67: 107-110.
- MÁTYÁS Cs. (2004): Population, conservation and ecological genetics. In: Burley, J. – Evans, J. – Youngquist, J. (eds.): *Encyclopedia of Forest Sciences*, Academic Press, London.
- NEI, M. (1987): *Molecular Evolutionary Genetics*. Columbia University Press, New York.
- RICHARDSON, B.A. – BRUNSFELD, J. – KLOPFENSTEIN, N.B. (2002): DNA from bird-dispersed seed and wind-disseminated pollen provides insights into postglacial colonization and population genetic structure of whitebark pine (*Pinus albicaulis*). *Mol. Ecol.* 11: 215-227.
- SCHNEIDER, S. – ROESSLI, D. – EXCOFFIER, L. (2000): Arlequin ver. 2000: A software for population genetics data analysis. Genetics and Biometry Laboratory, Department of Ecology and Anthropology, University of Geneva, Geneva.
- SLATKIN, M. (1995): A measure of population subdivision based on microsatellite allele frequencies. *Genetics* 139: 457-462.
- SZMIDT, A.E. (1982): Genetic variation in isolated populations of stone pine (*Pinus cembra*). *Silva Fenn.* 16: 196-200.
- VENDRAMIN, G.G. – LELLI, L. – ROSSI, P. – MORGANTE, M (1996): A set of primers for the amplification of 20 chloroplast microsatellites in Pinaceae. *Mol. Ecol.* 5: 595-598.
- VENDRAMIN, G. G. – ANZIDEI, M. – MADAGHIELE, A. – BUCCI, G. (1998): Distribution of genetic diversity in *Pinus pinaster* Ait. as revealed by chloroplast microsatellites. *Theor. Appl. Genet.* 97: 456-463.
- WILLIS, K.J. – BENNETT, D.K. – BIRKS, H.J.B. (1998): The late Quaternary dynamics of pines in Europe. In: Richardson D.M. (ed.): *Ecology and Biogeography of Pinus*. Cambridge University Press, Cambridge.
- WILLIS, K.J. – RUDNER, E. – SÜMEGI, P. 2000: The full-glacial forests of central and south-eastern Europe. *Quat. Res.* 53: 203-213.

Ecological Succession of Breeding Bird Communities in Deciduous and Coniferous Forests in the Sopron Mountains, Hungary

Dániel WINKLER *

Institute of Wildlife Management, University of West Hungary, Sopron, Hungary

Abstract – The relationship between breeding bird communities and different phases of secondary succession of deciduous (sessile oak – *Quercus petraea*) and coniferous (spruce – *Picea abies*) forests in the Sopron Mountains was studied. The bird censuses have been carried out in 5 different successional stages using the “double-visit fixed-radius point count technique”. A total of 38 bird species were encountered. There are typical bird communities to order to different stages of forest succession, containing unique bird species or species appearing predominantly in that successional stage. The study has shown structural changes in breeding bird communities during the succession. Bird species richness, density and diversity showed the same trends. Their numerical values were the lowest in the clear-cut areas with young (1-2 year old) plantations, and the highest in the mature stands. After a starting increase (shrub stage) there is a slight decline (10-12 year old stands) because of the canopy closure of the young trees. Further decrease can be observed in the low pole stands, as these habitats are no longer appropriate for species nesting in shrubs and not yet suitable for the hole-nesting ones. Species richness, density and diversity were lower in early pole and older spruce stands than in the corresponding oak stands.

bird communities / succession / vegetation structure / habitat / clear-cut

Kivonat – Fészkelő madárközösségek szukcessziójának vizsgálata a Soproni-hegység lomb- és fenyő állományaiban. A Soproni-hegységben kocsánytalan tölgyes és lúcfenyves másodlagos szukcessziójának madártani vonatkozásait vizsgáltam. A vizsgálatokhoz a vegetáció 5 különböző fejlődési stádiumát különítettem el. A fészkelő madárközösségek felvételéhez a kétszeri pontszámlálás (fix sugárral) madárszámlálási módszert alkalmaztam. A felvételek során összesen 38 faj fordult elő. A szukcesszió különböző stádiumaihoz jellemző, sajátos összetételű madárközösségek rendelhetők sokszor olyan stenök fajokkal, amelyek kizárólag vagy dominánsan csak az adott stádiumban fordulnak elő. Az erdei szukcesszió során a madárközösségek is szerkezeti változásokon mennek keresztül. A fajszám, denzitás és diverzitás hasonló trendet mutattak. Értékük legkisebb a tarvágást követő 1-2 éves felújítások esetében és legnagyobb az idős állományokban. A kezdeti emelkedés után (bokros, cserjés stádium) kisebb csökkenés mutatkozik (10-12 éves fiatalos), ami a nagyobb záródásnak tudható be. További csökkenés tapasztalható a rudas korú állományokban, mivel a nyíltabb területekre, bokrosokra jellemző énekesmadaraknak már nem, az odúlakóknak pedig még nem megfelelő ez a habitat. A kocsánytalan tölgyes illetve lúcfenyves fiatalosok madárközösségeinek fajgazdagsága, denzitása és diverzitása közel azonos volt. Jelentős eltérés mutatkozott azonban rudas és idősebb állományok esetében. Az elegyetlen lúcfenyvesek fajszám, denzitás és diverzitás tekintetében is szegényebb képet mutattak.

madárközösségek / szukcesszió / vegetáció-szerkezet / habitat / tarvágás

* dwinkler@emk.nyme.hu; H-9401 SOPRON, Pf. 132

1 INTRODUCTION

Several studies have shown that vegetation structure, its complexity and spatial dispersion are the primary determining factors in bird community composition (MacArthur – MacArthur 1961, Cody 1974, Wilson 1974, Blicke 1982), while other studies have pointed out that floristic composition of vegetation also plays an important role (Wiens – Rotenberry 1981, Ralph 1985, Moskát 1988a, Whelan 2000). The consecutive phases of a forest succession might provide habitats of different structure and often different plant species composition. These progressional changes can cause significant changes in the associated bird communities. The pattern and process of ecological bird community succession related to forest succession have been well studied and documented, mainly during the last few decades (Jones 1972, Shugart – James 1973, Glowacinski 1975, 1981, May 1982, Helle 1985, Moskát – Székely 1989, Bezzel 1990, Helle – Mönkkönen 1990, Schwab – Sinclair 1994, Rumble – Gobeille 1998, Lang et al. 2003).

The aim of this study is to determine the relationship between bird community composition, species richness, density, diversity and secondary succession of a deciduous and a coniferous forest in the Sopron Mountains. Further investigations were related to the comparison of structural properties of bird communities between these two forest types.

2 MATERIAL AND METHODS

2.1 Study area

This study is based on the breeding bird data of two successional series in managed deciduous (*Quercus petraea* – sessile oak) and managed coniferous (*Picea abies* – spruce) forests in the Sopron Mountains (N 47° 39-40', E 16° 26-34'). The elevation of the area ranges from 450 to 550 m above sea level. Five different phases of secondary forest succession have been investigated for both forest types.

Succession stages in deciduous (sessile oak) forest

- I_D: Recently clear-cut area – 1-2 year old afforestation. The area is planted with young trees of up to 50 cm height. The cover of herb layer is 80-90%, including species e.g. *Calamagrostis epigeios*, *Euphorbia amygdaloides*, *Carex digitata*, *Cirsium vulgare*, *Dactylis glomerata*.
- II_D: 4-7 year old afforestation – medium-dense shrub stage. Apart from the young trees, additional shrubs could also be found (*Rubus fruticosus*, *Rosa canina*). Height: up to 1,5 m. The cover of small trees and shrubs is 65-75%. Species in the herbaceous vegetation are e.g. *Deschampsia flexuosa*, *Carex digitata*, *Poa nemoralis*.
- III_D: 10-12 year old, dense stand – the cover of young trees is 80-85%. Height: 2-6 m.
- IV_D: Low pole stage – height of the trees 10-14 m. Canopy is closed, the cover is 80-90%. The ground vegetation includes species e.g. *Galium odoratum*, *Brachypodium sylvaticum*, *Geum urbanum*, *Deschampsia flexuosa*.
- V_D: “climax” forest – old sessile oak stands, height: 20-34 m. Apart from the main tree species *Quercus petraea*, scattered trees of *Carpinus betulus* and *Fagus sylvatica* can be found too. Cover is about 80-85%. Species in the herbaceous vegetation are e.g. *Carex sylvatica*, *Festuca drymeia*, *Brachypodium sylvaticum*, *Hieracium sylvaticum*.

Succession stages in coniferous (spruce) forest

- I_C: clear-cut area – 1-2 year old afforestation. Height of the young plantation is up to 60 cm. The cover of herbaceous layer is 75-90%, including species e.g. *Calamagrostis epigeios*, *Stenactis annua*, *Deschampsia flexuosa*.
- II_C: 4-6 year old spruce afforestation – medium-dense shrub stage. Additional shrubs (*Rubus fruticosus*, *Rosa canina*) can also be found. Height: up to 1.8 m. Tree and shrub coverage is 65-70%. Species in the ground vegetation are e.g. *Deschampsia flexuosa*, *Calamagrostis epigeios*, *Festuca drymeia*.
- III_C: 10-12-year-old, dense stand – the cover of young trees is 85-90%. Height: 3-6 m. The common shrub *Rubus fruticosus* also appears among trees. Ground vegetation cover is not significant, species are e.g. *Deschampsia flexuosa*, *Stenactis annua*.
- IV_C: Low pole stand – height of the trees 11-14 m. Canopy is closed, cover is 85-95%. Shrub layer is completely missing, herbaceous vegetation is not significant.
- V_C: “climax” forest – old spruce stands. The cover is 75-85%, height: 24-32 m. Shrubs like *Rubus fruticosus* are also present. Species in the herbaceous vegetation are e.g. *Deschampsia flexuosa*, *Hieracium lachenalii*, *Luzula albida*.

These succession stages roughly correspond to the ones marked A, B, C, D and F as determined by Moskát – Székely (1989) in a beech forest.

2.2 Bird census

Bird censi were carried out twice during the breeding season (once in April and once in late May 2002) using the “double-visit fixed-radius point count technique” (Moskát 1986) which is a modified version of the French IPA point count method (Blondel et al. 1970). Observations took place in early mornings (about 4.00-9.00 am) inside a circle with fixed distance radius (100 m) around the sample points. With the use of fixed radius the relative density values of breeding pairs can be calculated easier than using the species-specific coefficients of detectability described in the original technique. 61 sampling points were set out with a total sampling area of about 192 ha. At each survey station singing males and observed pairs were recorded during the 20 min. count period. The method used was suitable for recording pigeon- (*Columbiformes*), nightjar- (*Caprimulgiformes*), woodpecker- (*Piciformes*) and passerine bird (*Passeriformes*) species only.

2.3 Data analysis

Avian species richness was calculated for each successional stage. Due to different number of sampling points in the different stages, it was relevant to calculate the expected number of species on plots of equal sizes for each stage using rarefaction analyses to allow a more reliable comparison of bird communities. Rarefaction is a statistical method that estimates the number of species expected from a given sample of point counts based on multiple random sampling (James – Rathbun 1981, Moskát 1988b). The expected number of species [$E(S_n)$] in a random sample of n pairs drawn without replacement from N pairs is calculated by:

$$E(S_n) = \sum_{i=1}^S \left[1 - \frac{\binom{N - N_i}{n}}{\binom{N}{n}} \right]$$

S : total number of species.

Relative density-values of all species were calculated for each stage. Out of the results of two bird censi (carried out in April and May) the higher density values were chosen for each species.

Bird species diversity (H) was also computed for each stage of both sessile oak and spruce forests using the Shannon-Weaver formula.

To compare diversity values of two assemblages (H_1 and H_2) a t test was used to determine if they are significantly different (Hutcheson 1970).

Pielou's equitability index (J) was used to measure the evenness of species distribution within the community (Pielou 1966).

3 RESULTS

Table 1 shows the most important structural properties of breeding bird communities recorded.

Table 1. Structural properties of bird communities in different successional stages, by stand types

Successional stages	Species richness (S)	Expected number of species [$E(S_n)$]	Density (D) (pairs/10 ha)	Diversity (H)	Evenness (J)
I _D	8	7.14	8.92	1.87	0.90
I _C	8	6.44	7.42	1.94	0.93
II _D	16	13.28	26.28	2.42	0.87
II _C	14	13.12	23.32	2.43	0.92
III _D	14	12.04	22.96	2.27	0.86
III _C	12	10.51	19.84	2.20	0.89
IV _D	13	11.71	20.16	2.21	0.86
IV _C	8	8.00	10.37	1.88	0.90
V _D	24	22.58	36.29	2.89	0.91
V _C	19	16.74	29.94	2.72	0.92

Breeding bird species richness and its estimated values corrected for differences in plot size were significantly higher in mature forests than it is in young afforestations. Species richness has shown a rapid initial increase during the first two successional stages following clear-cutting. This first increase peaked in the 4-7 year old plantations of both deciduous and coniferous stands (stage II) The species of bird communities in these shrub stages often include species characteristic for open habitats, like the yellowhammer (*Emberiza citrinella*). There is a slight decrease in stages II_D and II_B mainly because of the closed canopy in these dense stands. Species like the tree pipit (*Anthus trivialis*) or the nightjar (*Caprimulgus europaeus*) can no longer find their optimal nesting habitats in these stands. Further decrease of bird species richness can be found in stage IV. This decrease is moderate in the case of the oak stands (IV_D) but very drastic in pure spruce stands (IV_C) where species richness dropped to the lowest observed level, except for clear-cut areas. Generally, habitats in these low pole stands are no longer appropriate for bird species nesting in shrubs such as the blackcap (*Sylvia atricapilla*) or the red-backed shrike (*Lanius collurio*), and not yet suitable for the hole-nesting ones like tits (*Paridae*) and woodpeckers (*Piciformes*). Species richness was the highest in both deciduous and coniferous mature stands (V_D and V_C). Some characteristic hole-nesting species appeared in this stage, such as the stock dove (*Columba oenas*), the great spotted woodpecker (*Dendrocopus major*), the great tit (*Parus major*), the collared flycatcher (*Ficedula albicollis*) and especially in old spruce stands the coal tit (*Parus ater*).

Table 2. Density values (pairs/10 ha) of bird species in different successional stages

Species	Succession stages									
	I _D	I _C	II _D	II _C	III _D	III _C	IV _D	IV _C	V _D	V _C
	Density (pairs/10 ha)									
<i>Columba oenas</i> L.	-	-	-	-	-	-	-	-	0.64	0.64
<i>Columba palumbus</i> L.	-	-	-	-	-	-	-	-	0.64	-
<i>Caprimulgus europaeus</i> L.	-	0.53	-	0.53	-	-	-	-	-	-
<i>Jynx torquilla</i> L.	-	-	-	-	-	-	-	-	0.64	-
<i>Picus viridis</i> L.	-	-	-	-	-	-	-	-	0.64	-
<i>Dryocopus martius</i> L.	-	-	-	-	-	-	-	-	0.64	-
<i>Dendrocopos major</i> L.	-	-	-	-	-	-	-	-	0.64	0.64
<i>Anthus trivialis</i> L.	1.27	1.06	0.80	2.12	-	-	-	-	1.27	-
<i>Prunella modularis</i> L.	0.64	1.06	3.18	2.12	3.18	1.36	0.53	0.80	0.64	0.64
<i>Erithacus rubecula</i> L.	1.27	1.06	1.99	1.59	4.24	1.82	4.25	0.80	4.45	1.91
<i>Saxicola torquata</i> L.	0.64	0.53	-	-	-	-	-	-	-	-
<i>Turdus merula</i> L.	-	-	2.39	3.18	2.47	3.64	1.06	0.80	1.27	1.91
<i>Turdus philomelos</i> Ch.L.Brehm	-	-	0.40	0.53	0.35	0.45	0.53	0.80	0.64	1.91
<i>Locustella naevia</i> Bodd.	-	0.53	0.40	0.53	-	-	-	-	-	-
<i>Sylvia nisoria</i> Bechst.	-	-	-	-	0.35	0.45	-	-	-	-
<i>Sylvia curruca</i> L.	-	0.53	0.80	0.53	0.71	0.91	-	-	-	-
<i>Sylvia atricapilla</i> L.	0.64	-	3.18	2.12	3.18	4.55	2.12	0.80	1.27	0.64
<i>Phylloscopus sibilatrix</i> Bechst.	-	-	0.40	-	0.35	-	1.06	-	1.91	1.91
<i>Phylloscopus collybita</i> Vieill.	-	-	2.79	2.12	2.83	3.03	2.65	2.39	1.91	1.27
<i>Regulus regulus</i> L.	-	-	-	-	-	-	-	-	-	1.27
<i>Regulus ignicapillus</i> Temm.	-	-	-	-	-	-	-	-	-	1.27
<i>Ficedula albicollis</i> Temm.	-	-	-	-	-	-	-	-	1.91	-
<i>Aegithalos caudatus</i> L.	-	-	0.40	-	-	-	-	-	-	-
<i>Parus palustris</i> L.	-	-	-	-	0.35	-	-	-	1.27	-
<i>Parus ater</i> L.	-	-	-	-	-	-	-	0.80	-	2.55
<i>Parus caeruleus</i> L.	-	-	-	-	-	-	0.53	-	1.27	1.91
<i>Parus major</i> L.	0.64	-	0.40	-	-	-	1.06	-	3.18	2.55
<i>Sitta europea</i> L.	-	-	-	-	-	-	-	-	1.27	0.64
<i>Certhia brachydactyla</i> Ch.L.Brehm	-	-	-	-	-	-	-	-	1.27	0.64
<i>Lanius collurio</i> L.	0.64	-	1.59	2.12	0.35	0.91	-	-	-	-
<i>Garrulus glandarius</i> L.	-	-	-	-	-	-	-	-	0.64	0.64
<i>Sturnus vulgaris</i> L.	-	-	-	-	-	-	-	-	0.64	-
<i>Fringilla coelebs</i> L.	-	-	1.59	0.53	3.18	1.36	4.78	3.18	6.37	5.73
<i>Carduelis chloris</i> L.	-	-	0.40	1.06	0.71	0.91	0.53	-	-	-
<i>Carduelis carduelis</i> L.	-	-	-	-	-	-	0.53	-	-	-
<i>Loxia curvirostra</i> L.	-	-	-	-	-	-	-	-	-	1.27
<i>Coccothraustes coccothraustes</i> L.	-	-	-	-	-	-	0.53	-	1.27	-
<i>Emberiza citrinella</i> L.	3.18	2.12	5.57	4.24	0.71	0.45	-	-	-	-
Total density:	8.92	7.42	26.2	23.3	22.9	19.8	20.1	10.3	36.2	29.9

Table 2 shows the pair density of each bird species encountered in different succession stages. Changes and trends in bird community density (Figure 1) paralleled the changes described for bird species richness. As for species richness, the increases from stage I to stage II and from stage IV to stage V were significant for both deciduous and coniferous forests, and so the drastic decrease from stage III_C to stage IV_C for the spruce stands.

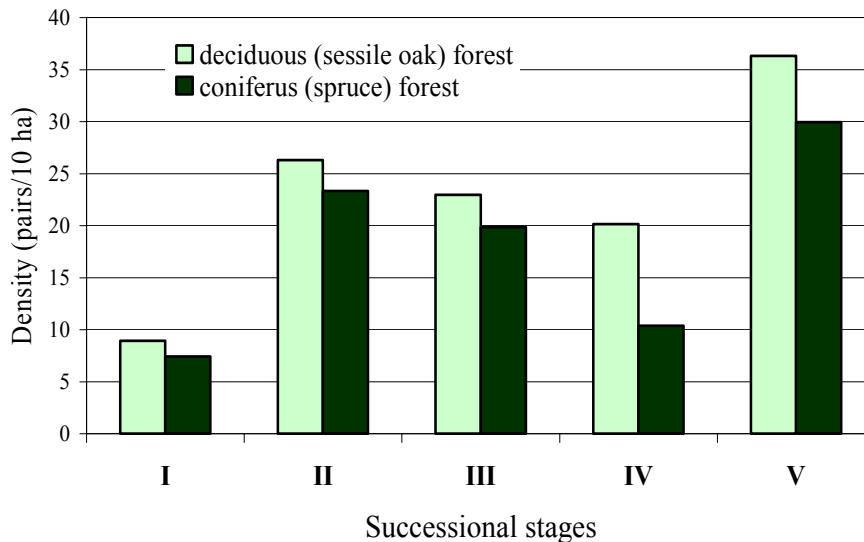

Figure 1. Changes of density during the succession

Bird community diversity shows a similar trend expressed in species richness and density. Table 3 shows the results of *t* test based on Shannon indices. For what concerns stages I, II and III, there are no remarkable differences between diversity values of bird communities recorded in deciduous and coniferous afforestations (*t*-values are very low comparing diversity values of stages I_D and I_C; II_D and II_C; III_D and III_C). With reference to diversity values in stages IV and V, the differences between deciduous and coniferous stands are higher but not yet significant ($P=0.05$). Significant differences (above 5 percent probability level) can principally be observed comparing diversity values of stages I and II; I and V; III and V; IV and V. This phenomenon clearly shows that clearcut fields (stage I) and mature stands (stage V) represent two extremes.

Table 3. Results (*t*-values) of comparison of Shannon diversity (*H*) values. Significant differences are italicized (at $P=0.05$ level)

Succ. stages	I _D	I _C	II _D	II _C	III _D	III _C	IV _D	IV _C	V _D
I _C	0.268								
II _D	2.255	2.191							
II _C	2.236	2.168	0.005						
III _D	1.655	1.512	1.076	1.050					
III _C	1.318	1.131	1.419	1.390	0.459				
IV _D	1.289	1.101	1.200	1.182	0.350	0.050			
IV _C	0.058	0.204	2.162	2.145	1.567	1.236	1.211		
V _D	4.004	4.148	2.970	2.897	3.994	4.070	3.604	3.902	
V _C	3.374	3.444	1.942	1.890	2.965	3.128	2.751	3.276	0.990

Evenness values (Pielou's equitability index) haven't shown any trend during the succession. The relative high values in stages I_D, I_C and IV_C can be explained with the low number of species, with a relevant implication on the algorithm used.

Table 4 shows numerical dominance values of the most dominant bird species (Dominance % > 10%) in different successional stages. Bird species with a high dominance value in all stages could be found neither in deciduous, nor in coniferous successional series.

The most frequent species were the robin (*Erithacus rubecula*) appearing with high dominance in stages I_C, I_D, III_D and V_D (but recorded also in all other stages) and the chaffinch (*Fringilla coelebs*) appearing with high dominance in stages III_D, IV_D, IV_C, V_C and V_D (but recorded also in stages II_D, II_C and III_C with lower dominance). These species are generalists regarding forest succession.

Table 4. Dominance values (%) of the most dominant bird species ($D\% > 10\%$) in successional stages, by stand types

Sessile oak stands		Spruce stands	
Succ. stages	Species – Dominance (%)	Succ. stages	Species – Dominance (%)
I _D	<i>Emberiza citrinella</i> – 35.71 <i>Erithacus rubecula</i> – 14.29 <i>Anthus trivialis</i> – 14.29	I _C	<i>Emberiza citrinella</i> – 28.57 <i>Erithacus rubecula</i> – 14.29 <i>Prunella modularis</i> – 14.29 <i>Anthus trivialis</i> – 14.29
II _D	<i>Emberiza citrinella</i> – 21.21 <i>Sylvia atricapilla</i> – 12.12 <i>Prunella modularis</i> – 12.12 <i>Phylloscopus collybita</i> – 10.60	II _C	<i>Emberiza citrinella</i> – 18.18 <i>Turdus merula</i> – 13.64
III _D	<i>Erithacus rubecula</i> – 18.46 <i>Sylvia atricapilla</i> – 13.85 <i>Prunella modularis</i> – 13.85 <i>Fringilla coelebs</i> – 13.85 <i>Phylloscopus collybita</i> – 12.31 <i>Turdus merula</i> – 10.77	III _C	<i>Sylvia atricapilla</i> – 22.73 <i>Turdus merula</i> – 18.18 <i>Phylloscopus collybita</i> – 13.64
IV _D	<i>Fringilla coelebs</i> – 23.68 <i>Phylloscopus collybita</i> – 13.16 <i>Sylvia atricapilla</i> – 10.53	IV _C	<i>Fringilla coelebs</i> – 30.77 <i>Phylloscopus collybita</i> – 23.08
V _D	<i>Fringilla coelebs</i> – 17.54 <i>Erithacus rubecula</i> – 12.28	V _C	<i>Fringilla coelebs</i> – 19.15

4 DISCUSSION

Successional trends in bird communities appeared to be determined by the development of vegetation patch types appropriate to specific bird-guilds. Species richness, bird density and diversity were the lowest in the earliest successional stage and the highest in the old stands. May (1982) found the same result in other studies of old-field forest succession. A sharp increase in the shrub stages (II) followed by declines in the dense thicket stages (III) and early pole stages (IV) are characteristic for successions of European forests (Głowacinski 1975, Moskát – Székely 1989, Helle 1985).

Each successional stage supported a characteristic community of breeding bird species. 53% of the observed species appeared in more than one successional stage. However, many species were still found in only one phase of secondary forest succession. In every successional stage a unique or predominant bird species characteristic for that successional stage could be identified.

The grasshopper warbler (*Locustella naevia*) was a very rare species in Hungary until the 1980's and appeared only in wet meadow habitats. Kárpáti (1982) reported for the first time that this species appeared as breeding bird species in a completely new habitat, in clear-cut

areas and young afforestations in the Sopron Mts. The grasshopper warbler was recorded in stages I_C, II_D and II_C.

Another characteristic species in clear-cut areas is the nightjar. This ground-nesting species prefers the 1-7 year old afforestations (stages I and II) where the cover of the young trees is lower and the canopy is not yet closed, but it is completely absent in the dense thickets (stage III). Optimal habitats for the nightjar in the Sopron Mts. are young coniferous plantations and forest edges (Winkler 2001).

A hole-nesting species, the great tit was also surveyed in early successional stages (I_D and II_D). According to Krebs (1971), these are mostly young male birds not breeding in the actual breeding season. This phenomenon was also described by Moskát – Székely (1989).

The appearance of the dunnock (*Prunella modularis*) with relatively high and medium-high abundance in all successional stages was also an unusual phenomenon. All singing males of the dunnock were recorded during the first censi in April but one individual was counted also during late May censi. A theoretical explanation might be that these birds are not breeding but only staying in this area during their late springtime migration when the singing and territorial activity is already noteworthy. The breeding of the dunnock has been proved only once (a nest with 4 eggs has been found in a spruce plantation – stage II_C – during a survey).

Most of the spruce forests in the Sopron Mts. were damaged because of a heavy bark beetle gradation (*Ips typographus*). In the surveyed older stands (stage V_C) damaged trees with cracked barks provided optimal nesting places for the short-toed tree creeper (*Certhia brachydactyla*) and for the coal tit. In the less closed parts of these stands, the aggressively expanding shrub-vegetation (e.g. *Rubus fruticosus*) attracted the shrub-nesting species such as the blackcap (*Sylvia atricapilla*). This caused the relatively high species richness and diversity values in this stage.

5 CONCLUSIONS

The results of this study have shown that tree species (deciduous or coniferous) seems to be less important for bird community composition and has no particular effect on avian species richness, density and diversity in young afforestations. But the difference of the mentioned characteristics appear to be dramatic between the early pole sessile oak and the pure spruce forests (where their numerical values were almost as low as in the clearcut stage).

Avian assemblages are determined, to a degree, by vegetation and forest structure. Forest management has therefore a direct and strong effect on bird community composition, avian species richness, density and diversity. Late-successional forests are very important to several species of birds, especially to the cavity-nesting ones, and usually the avian diversity is the highest in these stands. On the other hand, the study has also shown that young clearcuts support vastly different bird communities and enrich the global avian diversity. But it has also been proved that most of the species of clear-cut areas also appear in small forest gaps caused by small-scale natural disturbance (FACCIO 2003).

For what concerns the clearcutting system, another important factor related to avian diversity should be mentioned. The remnant (seed) trees play an important role not only in forest regeneration, they can also be considered as “ecological Noah’s arks” for birds, insects and other animals.

Acknowledgments: I would like to thank my professors Sándor Faragó and György Traser for their help and support. I am also grateful to Adrienne Winkler, Savino De Bonis and Addalena Smith for the precious assistance.

REFERENCES

- BEZZEL, E. (1990): „Vogelsukzessionen” auf Kleinflächen: Daten einer 22-jährigen Beobachtungsreihe. Die Vogelwelt Jg. 111: 46-59.
- BLICKE, G. (1982): Breeding songbird community structure: influences of plot size and vegetation structure. *Acta Oecologica, Oecol. Gen.* 3: 511-521.
- BLONDEL, J. – FERRY, C. – FROCHOT, B. (1970): La méthode des indices ponctuels d’abondance (IPA) ou des relevés d’avifaune par „station d’écoute”. *Alauda* 38: 55-7.
- CODY, M. L. (1974): Competition and the structure of bird communities. Series: Monographs in Population Biology. Princeton Univ. Press. Princeton. 326 p.
- FACCIO, S. D. (2003): Effects of ice storm-created gaps on forest breeding bird communities in central Vermont. *Forest Ecology and Management* 186: 133-145.
- GLOWACINSKI, Z (1975): Succession of bird communities in the Niepołomice Forest (Southern Poland). *Ekologia Polska* 23(2): 231-263.
- GLOWACINSKI, Z (1981): Stability in bird communities during the secondary succession of a forest ecosystem. *Ekologia Polska* 29: 73-95.
- HELLE, P. (1985): Effects of forest regeneration on the structure of bird communities in northern Finland. *Holarct. Ecol.* 8: 120-132.
- HELLE, P. – MÖNKKÖNEN, M. (1990): Forest succession and bird communities: theoretical aspects and practical implications. In: Keast, A. (ed.): *Biogeography and ecology of forest bird communities*. The Hague, SPB Academic Publishing. 299-318.
- HUTCHESON, K. (1970): A test for comparing diversities based on the Shannon formula. *Journal of Theor. Biology* 29: 151-154.
- JAMES, F. C. – RATHBUN, S. (1981): Rarefaction, relative abundance, and diversity of avian communities. *Auk* 98: 785-800.
- JONES, P. H. (1972): Succession in breeding bird populations of sample Welsh oakwoods. *British Birds* 65: 291-299.
- KÁRPÁTI, L. (1984): Jelenségek. [Phenomena]. *Madártani Tájékoztató* 1984. April-June: 86-87 (in Hung.)
- KREBS, J. R. (1971): Territory and breeding density in the great tit, *Parus major* L. *Ecology* 52: 2-22.
- LANG, C. – SCHERZINGER, W. – KONOLD, W. (2003): Sukzession der Avifauna auf Störungsflächen im Nationalpark Bayerischer Wald. *Ornithologischer Anzeiger* 42(1): 1-15.
- MACARTHUR, R. H. – MACARTHUR, J. W. (1961): On bird species diversity. *Ecology* 42(3): 594-598.
- MAY, P. G. (1982): Secondary succession and breeding bird community structure: patterns of resource utilization. *Oecologia* 55: 208-216.
- MOSKÁT, CS. (1986): Madárszámlálási módszerek hatékonyságának vizsgálata a Pilis-hegységben. [Efficiency of some bird census methods in the Pilis Mountains]. *Állattani Közlemények* 73: 251-261 (in Hungarian)
- MOSKÁT, CS. (1988a): Breeding bird community and vegetation structure in a beech forest in the Pilis-Mountains, N. Hungary. *Aquila* 95: 105-112.
- MOSKÁT, CS. (1988b): Diverzitás és rarefaction. [Diversity and rarefaction]. *Aquila* 95: 97-103 (in Hungarian)
- MOSKÁT, CS. – SZÉKELY, T. (1989): Habitat distribution of breeding birds in relation to forest succession. *Folia Zoologica* 38(4): 363-376.
- PIELOU, E. C. (1966): The measurement of diversity in different types of biological collection. *Journal of Theor. Biology* 13: 131-144.
- RALPH, C. J. (1985): Habitat association patterns of forest and steppe birds of northern Patagonia. *The Condor* 87: 471-483.
- RUMBLE, M. A. – GOBEILLE, J. E. (1998): Bird community relationship to succession in green ash (*Fraxinus pennsylvanica*) Woodlands. *Am. Midl. Nat.* 140: 372-381.
- SCHWAB, F. E. – SINCLAIR, A. R. E. (1994): Biodiversity of diurnal breeding bird communities related to succession in the dry douglas-fir forests of southeastern British Columbia. *Can. J. For. Res.* 24: 2034-2040.
- SHUGART, H. H. – JAMES, D. (1973): Ecological succession of breeding bird populations in Northwestern Arkansas. *Auk* 90: 62-77.

- WHELAN, C. (2000): Foliage structure influences foraging of insectivorous forest birds: an experimental study. *Ecology* 82: 219-231.
- WIENS, J. A. – ROTENBERRY, J. T. (1981): Habitat associations and community structure of birds in shrubsteppe environments. *Ecol. Mon.* 51: 21-41.
- WILSON, M. F. (1974): Avian community organization and habitat structure. *Ecology* 55: 1017-1029.
- WINKLER, D. (2001): Adatok a lappantyú (*Caprimulgus europaeus* L.) habitat-választásához és költésbiológiájához. [New data on the habitat choice and breeding biology of nightjar (*Caprimulgus europaeus* L.)]. Az Erdőmérnöki Kar Tudományos Konferenciájának előadásai. NYME, Sopron. 53-58 (in Hungarian)

Checklist of Herbivorous Insects of Native and Exotic Oaks in Hungary I. (Lepidoptera)

György CSÓKA* – Csaba SZABÓKY

Department of Forest Protection, Hungarian Forest Research Institute, Mátrafüred, Hungary

Abstract – As far as is currently known, 308 lepidopteran species belonging to 32 families feed on oaks in Hungary. The family Geometridae is the richest in quercivorous (oak feeding) species (63), followed by Noctuidae (62), and Tortricidae (39). Hungarian data are available for 69.4% of this fauna (215 species). Numbers of species-level hostplant data are *Quercus cerris*: 65, *Quercus petraea*: 119, *Quercus pubescens*: 89, *Quercus robur*: 111, *Quercus rubra*: 16. These species numbers exceed the species numbers published 10 years ago by 70%.

***Quercus* / herbivore insects / Lepidoptera**

Kivonat – A magyarországi tölgyek herbivor rovarainak listája I. Jelenleg 32 családba tartozó 308 magyarországi lepkefajról tudjuk, hogy tölgyeken táplálkozik. Tölgyön táplálkozó fajokban leggazdagabb az araszólepkék (63 faj), a bagolylepkék (62 faj) és a sodrómolyok családja (39 faj). A 308 lepkefaj 69,4 %-a (215 faj) eredeti, magyarországi adatot alapul véve került fel a listára. Az egyes tölgyfajok esetében az alábbi számú lepkefajra vonatkozóan vannak faji pontosságú tápnövény adataink: *Quercus cerris*: 65, *Quercus petraea*: 119, *Quercus pubescens*: 89, *Quercus robur*: 110, *Quercus rubra*: 16. Ezek a fajszámok mintegy 70 %-kal haladják meg a 10 évvel korábban publikált fajlista hasonló értékeit.

***Quercus* / herbivor rovarok / Lepidoptera**

1 INTRODUCTION

The richness and differences of herbivore insect guilds on different trees and shrubs has received considerable attention in insect ecological research over the last three decades (Strong – Levin, 1979; Neuvonen – Niemelä 1981, 1983;. Kennedy – Southwood, 1984; Karban – Ricklefs 1983, 1984;. Altenkirch, 1986; Leather, 1986; Szentkirályi – Kozár, 1991; Gaston, 1992; etc.).

Hungarian knowledge on this topic is rather sporadic. Csóka (1996) compiled the list of herbivore insects of different tree species and particularly those feeding on oaks (1994, 1998). These lists were mainly based on literature data. According to these checklists, the number of herbivorous insects feeding on oaks in Hungary is about 630. This number is very high

* Corresponding author: gycsoka@mail.datanet.hu; H-3232 MÁTRAFÜRED, Pf. 2

compared to the 423 published from Great Britain (Southwood – Kennedy, 1984) and 298 from Germany (Altenkirch, 1986). The total of 630 species is also very high in comparison to herbivore richness associated with any other genera of woody plants in Hungary. It is nearly 40 % higher than that of the second highest, *Salix*. 46,5% of the 630 species belong to the Lepidoptera. With this share the Lepidoptera is by far the richest herbivore insect order feeding on oaks in Hungary, with more than twice the species richness of the Hymenoptera (131) and Coleoptera (121) (Csóka 1994, 1998).

This article is the first part of a series planned to have 3 parts. It deals only with Lepidopteran herbivores of oaks. Compared to former works it lists far more original Hungarian rearing data resulting from intensive collecting of oak herbivore insects. There is no need to emphasise the higher value of reliable original rearing data compared to the sometimes unreliable literature data.

This list deals only with the species where the larvae or the adult feed on living tissues of oaks, and does not deal with saproxylophagous species feeding on dead wood, on lichens or in fungi living on trees.

2 ORIGIN OF THE DATA LISTED

The paper primarily considers original Hungarian rearing data, but lists also literature data if necessary. The data are classified into three categories.

- Previously published or as yet unpublished original data of the two authors. These data are indicated by the abbreviated names of the authors (Cs.Gy.= György Csóka, Sz.Cs.= Csaba Szabóky).
- Original Hungarian rearing data. Only articles in which original rearing data were published are considered (Tallós 1961; Szöcs 1963, 1971, 1973, 1977; Mészáros 1969, 1972, 1974, 1981; Herczig et al 1980; Szeőke 1982; Csóka 1991; Csóka – Hirka 2002).
- Foreign host plant records are listed only in cases where data from the previous two categories were not available. We have tried to avoid listing data from foreign handbooks because it is quite likely that the data presented date from other, earlier handbooks.

The majority of the foreign data are from Patočka et al. (1999). This monograph is based on original Slovakian data, and therefore the reliability of the data together with the geographical closeness make them more appropriate.

3 CHECKLIST

The families and the species within the families and also the host plants are listed in alphabetical order. In the list there are * signs following the names of 6 *Pammene* species. These 6 species have a very special life history. Their larvae feed on gall tissues inside the galls formed by gall wasps belonging to family Cynipidae. But because they feed on living plant tissues they must be considered as herbivores.

Arctiidae

- Callimorpha dominula* Linnaeus, 1758
Quercus petraea: Csóka, 1991
Euplagia quadripunctaria Poda 1761
Quercus petraea: Csóka, 1991
Hyphantria cunea Drury, 1773
Quercus robur: Csóka, 1991
Quercus rubra: Cs.Gy.

Bucculatricidae

- Bucculatrix ulmella* Zeller, 1848
Quercus cerris: Szócs, 1971
Quercus petraea: Szócs, 1977

Chimabachidae

- Diurnea fagella* ([Denis – Schiffermüller], 1775)
Quercus petraea: Cs.Gy.
Quercus robur: Cs.Gy.

Coleophoridae

- Coleophora anatipennella* (Hübner, 1796)
Quercus sp.: Szócs 1977
Coleophora currucipennella Zeller, 1839
Quercus cerris: Szócs, 1971
Quercus pubescens: Herczig et al. 1980
Coleophora flavipennella (Duponchel, 1843)
Quercus sp.: Szócs 1977
Coleophora ibipennella Zeller, 1849
Quercus sp.: Szócs 1977
Coleophora kuehnella Zincken, 1813
Quercus petraea: Cs.Gy.
Quercus robur: Cs.Gy.
Coleophora lutipennella (Zeller, 1838)
Quercus petraea: Szócs, 1971
Quercus pubescens: Herczig et al. 1980

Cosmopterygidae

- Dystebenna stephensi* (Stainton, 1849)
Quercus sp.: Emmet 1988

Cossidae

- Cossus cossus* (Linnaeus, 1758)
Quercus cerris: Cs.Gy.
Quercus petraea: Cs.Gy.
Quercus pubescens: Cs.Gy.
Quercus robur: Cs.Gy.
Quercus rubra: Cs.Gy.
Zeuzera pyrina (Linnaeus, 1761)
Quercus rubra: Cs.Gy.

Drepanidae

- Drepana binaria* Hufnagel, 1767
Quercus petraea: Cs.Gy.
Quercus robur: Csóka, 1991
Drepana curvatula Borkhausen, 1790
Quercus sp.: Vojnits et al 1991
Drepana falcataria Linnaeus, 1758
Quercus petraea: Cs.Gy.

- Sabra harpagula* Esper, 1786
Quercus petraea: Cs.Gy.

Eriocraniidae

- Dyseriocrania subpurpurella* (Haworth, 1828)
Quercus sp.: Emmet 1988

Gelechiidae

- Anacamptis timidella* (Wocke, 1887)
Quercus cerris: Patočka et al 1999
Quercus pubescens: Patočka et al 1999
Carpatolechia decorella (Haworth, 1812)
Quercus sp.: Patočka et al 1999
Parastenolechia nigrinotella (Zeller, 1847)
Quercus pubescens: Patočka et al 1999
Pseudotelphusa paripunctella (Thunberg, 1794)
Quercus sp.: Patočka et al 1999
Pseudotelphusa scalella (Scopoli, 1763)
Quercus sp.: Patočka et al 1999
Psoricoptera gibbosella (Zeller, 1839)
Quercus petraea: Cs.Gy.
Stenolechia gemmella (Linnaeus, 1758)
Quercus macrocarpa: Csóka – Hirka, 2002
Quercus petraea: Cs.Gy.
Quercus pubescens: Cs.Gy.
Quercus robur: Cs.Gy.
Teleiodes luculella (Hübner, 1813)
Quercus sp.: Patočka et al 1999

Geometridae

- Abraxas grossulariata* (Linnaeus, 1758)
Quercus robur: Szeőke, 1982
Agriopis aurantiaria (Hübner [1799])
Quercus petraea: Csóka, 1991
Quercus pubescens: Csóka, 1991
Quercus robur: Csóka, 1991
Agriopis bajaria (Denis – Schiffermüller, 1775)
Quercus petraea: Cs.Gy.
Quercus pubescens: Cs.Gy.
Agriopis leucophaearia ([Denis – Schiffermüller], 1775)
Quercus petraea: Cs.Gy.
Quercus pubescens: Cs.Gy.
Quercus robur: Cs.Gy.
Agriopis marginaria (Fabricius, 1777)
Quercus petraea: Csóka, 1991
Quercus robur: Csóka, 1991
Alcis repandata (Linnaeus, 1758)
Quercus sp.: Patočka et al 1999
Alsophila aescularia (Denis – Schiffermüller, 1775)
Quercus petraea: Csóka, 1991
Quercus pubescens: Cs.Gy.
Quercus robur: Cs.Gy.
Alsophila quadripunctaria Esper, 1800
Quercus cerris: Herczig et al. 1980
Quercus petraea: Csóka, 1991
Quercus robur: Csóka, 1991

- Angerona prunaria* (Linnaeus, 1758)
Quercus sp.: Patočka et al 1999
- Apocheima hispidarium* (Denis – Schiffermüller, 1775)
Quercus petraea: Cs.Gy.
Quercus pubescens: Cs.Gy.
- Quercus robur*: Cs.Gy.
- Asthena albulata* Hufnagel, 1767
Quercus sp.: Fajčík – Slamka, 1996
- Biston betularius* (Linnaeus, 1758)
Quercus petraea: Cs.Gy.
Quercus pubescens: Cs.Gy.
- Quercus robur*: Cs.Gy.
- Biston stratarius* (Hufnagel, 1767)
Quercus petraea: Cs.Gy.
- Quercus robur*: Cs.Gy.
- Boarmia arenaria* Hufnagel, 1767
Quercus sp.: Patočka et al 1999
- Boarmia punctinalis* (Scopoli, 1763)
Quercus sp.: Patočka et al 1999, Porter 1997
- Cabera pusaria* (Linnaeus, 1758)
Quercus sp.: Porter 1997
- Campaea honoraria* ([Denis – Schiffermüller], 1775)
Quercus sp.: Patočka et al 1999, Porter 1997
- Campaea margaritata* (Linnaeus, 1767)
Quercus petraea: Cs.Gy.
- Chloroclysta miata* (Linnaeus, 1758)
Quercus sp.: Patočka et al 1999
- Chloroclysta siterata* Hufnagel, 1767
Quercus sp.: Patočka et al 1999, Porter 1997
- Colotois pennaria* (Linnaeus, 1758)
Quercus cerris: Csóka, 1991
Quercus petraea: Csóka, 1991
Quercus pubescens: Cs.Gy., Sz.Cs.
Quercus robur: Csóka, 1991
Quercus rubra: Csóka – Hirka, 2001
- Comibaena bajularia* ([Denis – Schiffermüller], 1775)
Quercus sp.: Patočka et al 1999, Porter 1997
- Crocallis elinguaris* (Linnaeus, 1758).
Quercus pubescens: Cs.Gy.
- Cyclophora linearis* (Hübner [1799])
Quercus robur: Cs.Gy.
- Cyclophora porata* Linnaeus, 1767
Quercus cerris: Szócs, 1977
Quercus sp.: Mészáros, 1974, 1981
- Cyclophora punctaria* Linnaeus, 1758
Quercus robur: Csóka, 1991
- Cyclophora pupillaria* (Hübner, 1799)
Quercus robur: Porter 1997
- Cyclophora quercimontaria* Bastelberger, 1897
Quercus sp.: Patočka et al 1999
- Cyclophora ruficiliaria* HS
Quercus sp.: Mészáros, 1974
- Deileptenia ribeata* Clerck, 1759
Quercus sp.: Porter 1997
- Ectropis bistortata* Goeze, 1781
Quercus robur: Csóka, 1991
- Ectropis extersaria* (Hübner, 1799)
Quercus sp.: Porter 1997
- Ectropis consonaria* (Hübner, 1799)
Quercus sp.: Porter 1997
- Electrophaes corylata* (Thunberg, 1792)
Quercus sp.: Patočka et al 1999, Porter 1997
- Ennomos autumnarius* Werneburg, 1859
Quercus robur: Cs.Gy.
- Ennomos erosarius* ([Denis – Schiffermüller], 1775)
Quercus sp.: Patočka et al 1999, Porter 1997
- Ennomos quercinarius* Hufnagel, 1767
Quercus robur: Csóka, 1991
- Epirrita autumnata* Borkhausen, 1794
Quercus cerris: Cs.Gy.
Quercus robur: Cs.Gy.
- Epirrita christyi* Prout, 1906
Quercus cerris: Cs.Gy.
- Epirrita dilutata* ([Denis – Schiffermüller], 1775)
Quercus sp.: Porter 1997
- Erannis ankeraria* (Staudinger, 1861)
Quercus pubescens: Szócs, 1971
- Erannis defoliaria* (Clerck, 1759)
Quercus petraea: Csóka, 1991
Quercus robur: Csóka, 1991
Quercus rubra: Csóka – Hirka, 2001
- Eupithecia abbreviata* Stephens, 1831
Quercus sp.: Patočka et al 1999, Porter 1997
- Eupithecia dodoneata* Guenée, 1857
Quercus sp.: Patočka et al 1999, Porter 1997
- Eupithecia irriguata* Hübner, 1813
Quercus sp.: Patočka et al 1999, Porter 1997
- Hemithea aestivaria* (Hübner [1799])
Quercus sp.: Patočka et al 1999, Porter 1997
- Hypomecis roboraria* ([Denis – Schiffermüller], 1775)
Quercus petraea: Csóka, 1991
Quercus robur: Csóka, 1991
- Jodis lactearia* Linnaeus, 1758
Quercus sp.: Porter 1997
- Lomographa bimaculata* Fabricius, 1775
Quercus sp.: Koch, 1988
- Lycia hirtaria* (Clerck, 1759)
Quercus robur: Cs.Gy.
- Odontopera bidentata* (Clerck, 1759)
Quercus petraea: Cs.Gy.
- Operophtera brumata* (Linnaeus, 1758)
Quercus cerris: Cs.Gy.
- Quercus petraea*: Csóka, 1991
Quercus pubescens: Cs.Gy.
Quercus robur: Csóka, 1991
Quercus rubra: Csóka – Hirka, 2002
- Operophtera fagata* (Scharfenberg, 1805)
Quercus sp.: Patočka et al 1999

Peribatodes rhomboidarius (Denis – Schiffermüller, 1775)
Quercus robur: Csóka, 1991
Phigalia pilosaria ([Denis – Schiffermüller], 1775)
Quercus petraea: Csóka, 1991
Plagodis dolabraria (Linnaeus, 1767)
Quercus petraea: Cs.Gy.
Plagodis pulveraria Linnaeus, 1758
Quercus sp.: Patočka et al 1999
Poecilopsis pomonarius Hübner, 1790
Quercus sp.: Patočka et al 1999
Selenia dentaria (Fabricius, 1775)
Quercus robur: Cs.Gy.
Selenia lunularia Hübner, 1788
Quercus robur: Cs.Gy.
Selenia tetralunaria Hufnagel, 1767
Quercus robur: Cs.Gy.
Semiothisa alternaria (Hübner, 1809).
Quercus sp.: Patočka et al 1999
Semiothisa notata (Linnaeus, 1758)
Quercus sp.: Patočka et al 1999

Gracillariidae

Acrocercops brongniardella (Fabricius, 1798)
Quercus cerris: Szócs, 1963, Cs.Gy.
Quercus ilex: Csóka – Hirka, 2002
Quercus petraea: Cs.Gy.
Quercus pubescens: Cs.Gy.
Quercus robur: Cs.Gy.
Caloptilia alchimiella (Scopoli, 1763)
Quercus petraea: Cs.Gy.
Quercus pubescens: Cs.Gy.
Quercus robur: Cs.Gy.
Phyllonorycter abrasella (Duponchel, 1843)
Quercus cerris: Szócs, 1963, Cs.Gy.
Phyllonorycter delitella (Duponchel, 1843)
Quercus pubescens: Szócs, 1963
Phyllonorycter distentella (Zeller, 1846)
Quercus petraea: Szócs, 1971
Quercus pubescens: Szócs, 1971
Phyllonorycter harrisella (Linnaeus, 1761)
Quercus petraea: Szócs, 1977
Quercus robur: Szócs, 1963
Phyllonorycter heegeriella (Zeller, 1846)
Quercus petraea: Cs.Gy.
Quercus pubescens: Cs.Gy.
Quercus robur: Cs.Gy.
Quercus hartwissiana: Csóka – Hirka, 2002
Quercus iberica: Csóka – Hirka, 2002
Phyllonorycter ilicifoliella (Duponchel, 1843)
Quercus cerris: Szócs, 1963
Phyllonorycter lautella (Zeller, 1846)
Quercus cerris: Szócs, 1971
Quercus petraea: Szócs, 1971
Quercus robur: Szócs, 1971
Phyllonorycter muelleriella (Zeller, 1839)
Quercus robur: Szócs, 1963

Phyllonorycter parisiella (Wocke, 1848)
Quercus pubescens: Szócs, 1971
Phyllonorycter quercifoliella (Zeller, 1839)
Quercus cerris: Szócs, 1963, 1971
Quercus petraea: Szócs, 1963, Cs.Gy.
Quercus pubescens: Szócs, 1971
Quercus robur: Szócs, 1963, Cs.Gy.
Phyllonorycter roboris (Zeller, 1839)
Quercus acutissima: Csóka – Hirka, 2002
Quercus alba: Csóka – Hirka, 2001
Quercus castaneifolia: Csóka – Hirka, 2002
Quercus cerris: Cs.Gy.
Quercus dentata: Csóka – Hirka, 2001
Quercus hartwissiana: Csóka – Hirka, 2002
Quercus iberica: Csóka – Hirka, 2002
Quercus libani: Csóka – Hirka, 2002
Quercus macranthera: Csóka – Hirka, 2002
Quercus macrocarpa: Csóka – Hirka, 2002
Quercus petraea: Szócs, 1977, Cs.Gy.
Quercus pubescens: Szócs, 1963, Cs.Gy.
Quercus robur: Szócs, 1963, Cs.Gy.
Quercus trojana: Csóka – Hirka, 2002
Quercus turneri x pseudoturneri: Csóka – Hirka, 2002

Phyllonorycter saportella (Duponchel, 1840)
Quercus cerris: Szócs, 1971
Quercus petraea: Szócs, 1963
Quercus pubescens: Szócs, 1971
Phyllonorycter scitulella (Duponchel, 1843)
Quercus pubescens: Szócs, 1971
Spulerina simploniella (Fischer von Röslerstamm, 1844)
Quercus sp.: Szócs, 1963

Heliozelidae

Heliozela sericiella (Haworth, 1828)
Quercus sp.: Szócs 1977

Incurvariidae

Incurvaria masculella ([Denis – Schiffermüller], 1775)
Quercus sp.: Szócs 1977

Lasiocampidae

Eriogaster catax Linnaeus, 1758
Quercus cerris: Cs.Gy.
Quercus pubescens: Sz.Cs.
Quercus robur: Tallós, 1961
Eriogaster lanestris Linnaeus, 1758
Quercus robur: Cs.Gy.
Eriogaster rimicola Denis – Schiffenmüller, 1775
Quercus sp.: Szócs, 1963,
Gastropacha quercifolia Linnaeus, 1758
Quercus petraea: Csóka, 1991, Sz.Cs.
Quercus pubescens: Sz.Cs.
Quercus robur: Cs.Gy.

- Lasiocampa quercus* Linnaeus 1758
Quercus cerris: Cs.Gy., Sz.Cs.
Quercus petraea: Cs.Gy., Sz.Cs.
Quercus pubescens: Cs.Gy.
Quercus robur: Csóka, 1991
- Macrothylacia rubi* Linnaeus, 1758
Quercus petraea: Cs.Gy.
Quercus robur: Cs.Gy.
- Malacosoma neustria* Linnaeus, 1758
Quercus petraea: Mészáros, 1969, Cs.Gy., Sz.Cs.
Quercus pubescens: Sz.Cs.
Quercus robur: Mészáros, 1974, Cs.Gy., Sz.Cs.
Quercus rubra: Cs.Gy.
- Odonestis pruni* Linnaeus, 1758
Quercus sp.: Vojnits et al 1991
- Phyllodesma ilicifolia* Linnaeus, 1758
Quercus robur: Cs.Gy.
- Phyllodesma tremulifolia* Hübner, 1810
Quercus cerris: Sz.Cs.
Quercus petraea: Sz.Cs.
Quercus sp.: Vojnits et al 1991
- Poecilocampa populi* Linnaeus, 1758
Quercus petraea: Cs.Gy.
Quercus pubescens: Cs.Gy.
- Trichiura crataegi* Linnaeus, 1758
Quercus cerris: Tallós, 1961
- Limacodidae**
- Apoda limacodes* (Hufnagel, 1766)
Quercus petraea: Csóka, 1991, Sz.Cs.
Quercus pubescens: Cs.Gy.
Quercus robur: Csóka, 1991
- Heterogenea asella* ([Denis & Schiffermüller], 1775)
Quercus sp.: Porter, 1997
- Lycaenidae**
- Neozephyrus quercus* (Linnaeus, 1758)
Quercus petraea: Cs.Gy., Sz.Cs.
Quercus pubescens: Cs.Gy.
Quercus robur: Cs.Gy.
Quercus sp.: Mészáros, 1972
- Satyrium ilicis* (Esper, 1779)
Quercus pubescens: Cs.Gy.
- Lymantriidae**
- Arctornis l-nigrum* Müller, 1864
Quercus robur: Mészáros, 1974, Cs.Gy.
- Dicallomera fascelina* Linnaeus, 1758
Quercus petraea: Herczig et al. 1980
- Elkneria pudibunda* Linnaeus, 1758
Quercus cerris: Csóka, 1991
Quercus petraea: Csóka, 1991, Sz.Cs.
Quercus robur: Szeőke, 1982, Csóka, 1991
Quercus rubra: Cs.Gy.
- Euproctis chrysorrhoea* Linnaeus, 1758
Quercus petraea: Cs.Gy., Sz.Cs.
Quercus pubescens: Cs.Gy., Sz.Cs.
Quercus robur: Mészáros, 1974, Cs.Gy., Sz.Cs.
Quercus rubra: Cs.Gy.
- Euproctis similis* Fuessly, 1755
Quercus robur: Mészáros, 1974, Csóka, 1991, Csóka – Hirka, 2002
Quercus rubra: Cs.Gy.
- Leucoma salicis* Linnaeus, 1758
Quercus robur: Cs.Gy.
- Lymantria dispar* Linnaeus, 1758
Quercus alba: Csóka – Hirka, 2002
Quercus cerris: Szeőke, 1982, Csóka, 1991
Quercus frainetto: Cs.Gy.
Quercus imbricaria: Csóka – Hirka, 2002
Quercus macrocarpa: Csóka – Hirka, 2002
Quercus macrocarpa: Csóka – Hirka, 2002
Quercus palustris: Csóka – Hirka, 2002
Quercus palustris: Csóka – Hirka, 2002
Quercus petraea: Csóka, 1991, Sz.Cs.
Quercus pubescens: Csóka, 1991, Sz.Cs.
Quercus robur: Szeőke, 1982, Csóka, 1991
Quercus rubra: Csóka, 1991, Csóka – Hirka, 2002
- Lymantria monacha* Linnaeus, 1758
Quercus cerris: Cs.Gy.
Quercus petraea: Csóka, 1991
Quercus robur: Cs.Gy.
- Ocneria rubea* Fabricius, 1787
Quercus petraea: Herczig et al. 1980
- Orgya antiqua* Linnaeus, 1758
Quercus petraea: Csóka, 1991
Quercus robur: Csóka, 1991
Quercus rubra: Csóka, 1991
- Teia recens* Hübner, 1819
Quercus cerris: Cs.Gy.
Quercus petraea: Cs.Gy.
Quercus robur: Cs.Gy.
Quercus sp.: Mészáros, 1974
- Nepticulidae**
- Ectoedemia albifasciella* (Heinemann, 1871)
Quercus cerris: Szöcs, 1971
Quercus pubescens: Szöcs, 1971
- Ectoedemia atrifrontella* (Stainton, 1851)
Quercus petraea: Cs.Gy.
Quercus robur: Cs.Gy.
- Ectoedemia caradjai* (Groschke, 1944)
Quercus cerris: Szöcs, 1963

- Quercus petraea*: Szöcs, 1971
Quercus pubescens: Szöcs, 1971
Quercus robur: Szöcs, 1971
Ectoedemia cerris (Zimmermann, 1944)
 Quercus cerris: Szöcs, 1971
Ectoedemia contorta Nieukerken, 1985
 Quercus pubescens: Lastuvka & Lastuvka 1997
Ectoedemia gilvipennella (Klimesch, 1946)
 Quercus cerris: Szöcs, 1971
Ectoedemia heringi (Toll, 1934)
 Quercus pubescens: Szöcs 1963
 Quercus robur: Szöcs, 1971
Ectoedemia liechtensteini (Zimmermann, 1944)
 Quercus cerris: Szöcs, 1971
Ectoedemia longicaudella Klimesch, 1953
 Quercus sp.: Lastuvka & Lastuvka 1997
Ectoedemia rufifrontella (Caradja, 1920)
 Quercus pubescens: Szöcs, 1977
Ectoedemia subbimaculella (Haworth, 1828)
 Quercus cerris: Szöcs 1963
Quercus robur: Szöcs 1963
Stigmella atricapitella (Haworth, 1828)
 Quercus cerris: Szöcs, 1977
 Quercus pubescens: Szöcs, 1977
Stigmella basiguttella (Heinemann, 1862)
 Quercus cerris: Szöcs, 1971
 Quercus robur: Szöcs, 1971
Stigmella dorsiguttella (Johansson, 1971)
 Quercus sp.: Lastuvka & Lastuvka 1997
Stigmella eberhardi (Johanson, 1971)
 Quercus petraea: Szöcs, 1977
 Quercus pubescens: Szöcs, 1977
Stigmella roborella (Johansson, 1971)
 Quercus cerris: Szöcs, 1977
 Quercus pubescens: Szöcs, 1977
 Quercus robur: Szöcs, 1977
Stigmella ruficapitella (Haworth, 1828)
 Quercus cerris: Szöcs, 1977
 Quercus petraea: Szöcs, 1963
 Quercus pubescens: Szöcs, 1977
 Quercus robur: Szöcs, 1977
Stigmella samiatella (Zeller, 1839)
 Quercus macrocarpa: Csóka – Hirka, 2002
 Quercus robur: Szöcs, 1977
Stigmella svenssoni (Johansson, 1971)
 Quercus robur: Szöcs, 1977
Stigmella zoeeciella (Borkowski, 1972)
 Quercus cerris: Lastuvka & Lastuvka 1997
Stigmella zangherii (Klimesch, 1951)
 Quercus cerris: Szöcs, 1971
Acronicta aceris ([Denis – Schiffermüller], 1775)
 Quercus pubescens: Cs.Gy.
Acronicta alni (Linnaeus, 1767)
 Quercus sp.: Patočka et al 1999
Acronicta auricoma ([Denis – Schiffermüller], 1775)
 Quercus robur: Cs.Gy.
Acronicta euphorbiae ([Denis – Schiffermüller], 1775)
 Quercus robur: Tallós, 1961
Acronicta psi (Linnaeus, 1758)
 Quercus robur: Csóka, 1991
Acronicta rumicis (Linnaeus, 1758)
 Quercus petraea: Cs.Gy.
Acronicta tridens ([Denis – Schiffermüller], 1775)
 Quercus robur: Cs.Gy.
Agrochola circellaris (Hufnagel, 1766)
 Quercus sp.: Nowacki, 1998
Agrochola helvola (Linnaeus, 1758)
 Quercus sp.: Patočka et al 1999
Agrochola laevis (Hübner, [1803])
 Quercus sp.: Patočka et al 1999
Agrochola macilenta (Hübner, [1809])
 Quercus sp.: Patočka et al 1999
Agrotis exclamationis (Linnaeus, 1758)
 Quercus robur: Cs.Gy.
Agrotis segetum ([Denis – Schiffermüller], 1775)
 Quercus robur: Cs.Gy.
Agrotis vestigialis (Hufnagel, 1766)
 Quercus robur: Cs.Gy.
Amphipyra berbera Rungs, 1949
 Quercus robur: Cs.Gy.
Amphipyra pyramidea (Linnaeus, 1758)
 Quercus petraea: Csóka, 1991
 Quercus robur: Csóka, 1991
Astiotes dilecta (Hübner, [1808])
 Quercus sp.: Nowacki, 1998
Bena prasinana (Linnaeus, 1758)
 Quercus pubescens: Csóka, 1991
 Quercus robur: Csóka, 1991
Brachionycha nubeculosa (Esper, 1785)
 Quercus cerris: Cs.Gy.
Brachionycha sphinx (Hufnagel, 1766)
 Quercus cerris: Csóka, 1991
Catephia alchymista ([Denis – Schiffermüller], 1775)
 Quercus sp.: Patočka et al 1999
Catocala conversa (Esper, [1787])
 Quercus sp.: Nowacki, 1998

Noctuidae

- Catocala nymphagoga* (Esper, [1787])
Quercus cerris: Herczig et al. 1980, Cs.Gy.
Quercus petraea: Sz.Cs.
Quercus pubescens: Cs.Gy.
- Catocala promissa* ([Denis – Schiffermüller], 1775)
Quercus robur: Csóka, 1991
- Catocala sponsa* (Linnaeus, 1767)
Quercus petraea: Cs.Gy.
Quercus robur: Cs.Gy.
- Colocasia coryli* (Linnaeus, 1758)
Quercus petraea: Csóka, 1991
- Conistra erythrocephala* ([Denis – Schiffermüller], 1775)
Quercus sp.: Patočka et al 1999
- Conistra vaccinii* (Linnaeus, 1761)
Quercus petraea: Csóka, 1991
Quercus robur: Csóka, 1991
- Cosmia pyralina* ([Denis – Schiffermüller], 1775)
Quercus sp.: Patočka et al 1999
- Cosmia trapezina* (Linnaeus, 1758)
Quercus petraea: Csóka, 1991
Quercus robur: Csóka, 1991, Sz.Cs.
- Dichonia aeruginea* (Hübner, [1808])
Quercus pubescens: Patočka et al 1999
- Dichonia aprilina* (Linnaeus, 1758)
Quercus petraea: Cs.Gy.
- Dichonia convergens* ([Denis – Schiffermüller], 1775)
Quercus petraea: Cs.Gy.
- Dicycla oo* (Linnaeus, 1758)
Quercus cerris: Herczig et al. 1980
Quercus petraea: Cs.Gy.
Quercus pubescens: Cs.Gy., Sz.Cs.
- Dryobotodes eremita* (Fabricius, 1775)
Quercus cerris: Herczig et al. 1980
Quercus petraea: Cs.Gy.
Quercus pubescens: Cs.Gy.
- Dryobotodes monochroma* (Esper, [1790])
Quercus cerris: Patočka et al 1999
Quercus pubescens: Patočka et al 1999
- Eupsilia transversa* (Hufnagel, 1766)
Quercus cerris: Cs.Gy.
Quercus petraea: Cs.Gy.
Quercus robur: Cs.Gy.
- Herminia grisealis* ([Denis – Schiffermüller], 1775)
Quercus sp.: Patočka et al 1999
- Jodia croceago* ([Denis – Schiffermüller], 1775)
Quercus petraea: Cs.Gy.
- Lithophane hepatica* Clerk, 1759
Quercus sp.: Nowacki, 1998
- Lithophane ornitopus* (Hufnagel, 1766)
Quercus sp.: Patočka et al 1999
- Lithophane semibrunnea* (Haworth, 1809)
Quercus sp.: Koch, 1988
- Mamestra brassicae* (Linnaeus, 1758)
Quercus cerris: Herczig et al. 1980
- Mesogona acetosellae* ([Denis – Schiffermüller], 1775)
Quercus sp.: Patočka et al 1999
- Minucia lunaris* (Denis – Schiffermüller, 1775)
Quercus petraea: Cs.Gy.
Quercus pubescens: Cs.Gy.
- Moma alpium* (Osbeck, 1778)
Quercus sp.: Patočka et al 1999
- Nycteola revayana* (Scopoli, 1772)
Quercus sp.: Patočka et al 1999
- Orthosia cerasi* (Fabricius, 1775)
Quercus petraea: Cs. Gy.
Quercus pubescens: Cs.Gy.
Quercus robur: Mészáros, 1974
- Orthosia cruda* ([Denis – Schiffermüller], 1775)
Quercus petraea: Csóka, 1991
Quercus pubescens: Cs.Gy.
Quercus robur: Mészáros, 1974
- Orthosia gothica* ([Denis – Schiffermüller], 1775)
Quercus petraea: Csóka, 1991
Quercus robur: Csóka, 1991
- Orthosia gracilis* ([Denis – Schiffermüller], 1775)
Quercus petraea: Cs.Gy.
Quercus pubescens: Cs.Gy.
- Orthosia incerta* (Hufnagel, 1766)
Quercus cerris: Cs.Gy.
Quercus petraea: Csóka, 1991
Quercus pubescens: Sz.Cs.
Quercus robur: Cs.Gy.
- Orthosia miniosa* ([Denis – Schiffermüller], 1775)
Quercus petraea: Cs.Gy.
Quercus pubescens: Cs.Gy.
- Orthosia munda* ([Denis – Schiffermüller], 1775)
Quercus petraea: Cs.Gy.
Quercus pubescens: Cs.Gy.
- Paracolax tristalis* (Fabricius, 1794)
Quercus sp.: Nowacki, 1998
- Polypogon strigilata* (Linnaeus, 1758)
Quercus sp.: Patočka et al 1999
- Prodotis stolidia* (Fabricius, 1775)
Quercus sp.: Nowacki, 1998
- Pseudoips fagana* (Fabricius, 1781)
Quercus petraea: Cs.Gy.
Quercus pubescens: Sz.Cs.
- Rileyana fovea* (Treitschke, 1825)
Quercus pubescens: Patočka et al 1999
- Spudaea rutilata* (Esper, [1791])
Quercus sp.: Koch, 1988
- Trisateles emortualis* ([Denis – Schiffermüller], 1775)
Quercus sp.: Patočka et al 1999

Xanthia aurago ([Denis – Schiffermüller], 1775)
Quercus petraea: Cs.Gy.

Nolidae

Meganola strigula ([Denis – Schiffermüller], 1775)
Quercus sp.: Vojnits et al 1991
Meganola togatulalis Hübner, 1796
Quercus sp.: Vojnits et al 1991
Nola confusalis Herrich-Schäffer, 1847
Quercus sp.: Vojnits et al 1991

Notodontidae

Drymonia dodonea ([Denis – Schiffermüller], 1775)
Quercus petraea: Cs.Gy.
Quercus robur: Cs.Gy.
Drymonia melagona Borkhausen, 1790
Quercus sp.: Vojnits et al 1991
Drymonia querna ([Denis – Schiffermüller], 1775)
Quercus petraea: Cs.Gy.
Quercus pubescens: Sz.Cs.
Quercus robur: Cs.Gy.
Drymonia ruficornis Hufnagel, 1766
Quercus robur: Cs.Gy.
Euchila palpina Linnaeus, 1758
Quercus petraea: Cs.Gy.
Quercus pubescens: Cs.Gy.
Furcula furcula Clerck, 1759
Quercus robur: Cs.Gy.
Harpya milhauseri Fabricius, 1775
Quercus pubescens: Cs.Gy.
Quercus robur: Cs.Gy.
Notodonta dromedarius Linnaeus 1758
Quercus robur: Cs.Gy.
Ochrostigma velitaris Hufnagel, 1766
Quercus sp.: Vojnits et al 1991
Peridea anceps Goeze, 1781 *Quercus*
Quercus robur: Cs.Gy.
Phalera bucephala Linnaeus, 1758
Quercus castaneifolia: Csóka – Hirka, 2002
Quercus cerris: Csóka, 1991
Quercus petraea: Csóka, 1991
Quercus pubescens: Cs.Gy., Sz.Cs.
Quercus robur: Szeőke, 1982, Csóka, 1991
Quercus rubra: Cs.Gy.
Phalera bucephaloides Ochseneheimer, 1810
Quercus pubescens: Csóka, 1991
Ptilodon capucina Linnaeus, 1758
Quercus robur: Szeőke, 1982, Csóka, 1991

Spatalia argentina ([Denis – Schiffermüller], 1775)
Quercus petraea: Cs.Gy.
Quercus robur: Cs.Gy.
Stauropus fagi Linnaeus, 1758
Quercus cerris: Cs.Gy.
Quercus petraea: Cs.Gy.
Quercus pubescens: Sz.Cs.

Oecophoridae

Carcina quercana (Fabricius, 1775)
Quercus cerris: Cs.Gy.
Quercus frainetto: Cs.Gy.
Quercus petraea: Cs.Gy.
Quercus pubescens: Cs.Gy., Sz.Cs.
Quercus robur: Cs.Gy.

Pyralidae

Acrobasis consociella (Hübner, 1813)
Quercus cerris: Cs.Gy.
Quercus petraea: Cs.Gy.
Quercus sp.: Mészáros, 1972
Acrobasis glaucella Staudinger, 1859
Quercus cerris: Patočka et al 1999
Acrobasis sodalella Zeller, 1848
Quercus cerris: Stubnya 1955, Cs.Gy.
Quercus petraea: Cs.Gy.
Agrotera nemoralis (Scopoli, 1763)
Quercus sp.: Slamka, 1997
Conobathra repandana (Fabricius, 1798)
Quercus cerris: Niklos 1917, Cs.Gy.
Quercus robur: Patočka et al 1999
Conobathra tumidana ([Denis – Schiffermüller], 1775)
Quercus cerris: Szabóky, 2002
Quercus sp.: Mészáros, 1972
Cryptoblabes bistriga (Haworth, 1811)
Quercus sp.: Emmet 1988
Elegia similella (Zincken, 1818)
Quercus sp.: Patočka et al 1999
Phycita roborella ([Denis – Schiffermüller], 1775)
Quercus pubescens: Sz.Cs.
Quercus robur: Cs.Gy.
Quercus sp.: Mészáros, 1972

Sessiidae

Paranthrene insolita Le Cerf, 1914
Quercus pubescens: Szabóky, 2002
Synanthedon conopiformis (Esper, 1782)
Quercus sp.: Laštůvka – Laštůvka, 2001;
Patočka et al 1999
Synanthedon vespiformis (Linnaeus, 1761)
Quercus cerris: Cs.Gy.
Quercus petraea: Cs.Gy.
Synanthedon spuleri (Fuchs, 1908)

- Quercus* sp.: Laštůvka – Laštůvka, 2001
- Sphingidae**
Marumba quercus Linnaeus, 1758
Quercus petraea: Cs.Gy.
Quercus pubescens: Cs.Gy., Sz.Cs.
Quercus robur: Cs.Gy.
Mimas tiliae Linnaeus, 1758
Quercus robur: Cs.Gy.
- Saturniidae**
Aglia tau Linnaeus, 1758
Quercus petraea: Cs.Gy.
Antheraea yamamay Guerin-Meneville
Quercus robur: Csóka, 1991
Eudia pavonia Linnaeus, 1758
Quercus cerris: Csóka, 1991
Quercus robur: Szeőke, 1982
- Thaumetopoeidae**
Thaumetopoea processionea Linnaeus, 1758
Quercus cerris: Cs.Gy., Sz.Cs.
Quercus petraea: Cs.Gy., Sz.Cs.
Quercus robur: Csóka, 1991
- Thyatiridae**
Asphalia ridens Fabricius, 1787
Quercus petraea: Herczig et al. 1980
Asphalia ruficollis Fabricius, 1887
Quercus sp.: Vojnits et al 1991
Cymatophorima diluta ([Denis – Schiffermüller], 1775)
Quercus cerris: Herczig et al. 1980
Quercus petraea: Cs.Gy.
Quercus pubescens: Cs.Gy.
Quercus sp.: Mészáros, 1981
Tethea duplaris Linnaeus, 1761
Quercus petraea: Cs.Gy.
- Tischeriidae**
Tischeria decidua Wocke, 1876
Quercus castaneifolia: Csóka – Hirka, 2002
Quercus coccinea: Csóka – Hirka, 2002
Quercus libani: Csóka – Hirka, 2002
Quercus macranthera: Csóka – Hirka, 2002
Quercus petraea: Cs. Gy.
Quercus robur: Cs. Gy.
Tischeria dodonea Stainton, 1858
Quercus cerris: Szőcs, 1971
Quercus petraea: Cs.Gy.
Quercus pubescens: Cs.Gy.
- Tischeria ekebladella* (Bjerkander, 1795)
Quercus alba: Csóka – Hirka, 2002
Quercus castaneifolia: Csóka – Hirka, 2002
Quercus cerris: Szőcs, 1963, Cs.Gy.
Quercus dentata: Csóka – Hirka, 2002
Quercus imricaria: Csóka – Hirka, 2002
Quercus libani: Csóka – Hirka, 2002
Quercus macranthera: Csóka – Hirka, 2002
Quercus macrocarpa: Csóka – Hirka, 2002
Quercus petraea: Szőcs, 1963, Cs.Gy., Sz.Cs.
Quercus pontica: Csóka – Hirka, 2001
Quercus pubescens: Cs.Gy.
Quercus robur: Szőcs, 1963, Cs.Gy.
Quercus rubra: Csóka – Hirka, 2002
Quercus schumardii: Csóka – Hirka, 2002
Quercus velutina: Csóka – Hirka, 2002
- Tortricidae**
Acleris ferrugana ([Denis – Schiffermüller], 1775)
Quercus sp.: Patočka et al 1999
Acleris literana (Linnaeus, 1758)
Quercus sp.: Patočka et al 1999
Acleris quercinana (Zeller, 1849)
Quercus sp.: Razowski, 2001
Acleris rhombana ([Denis – Schiffermüller], 1775)
Quercus sp.: Patočka et al 1999
Acleris sparsana ([Denis et Schiffermüller], 1775)
Quercus sp.: Patočka et al 1999
Aleimma loeflingianum (Linnaeus, 1758)
Quercus petraea: Szontagh 1973, Cs.Gy.
Quercus pubescens: Szontagh 1973, Cs.Gy., Sz.Cs.
Quercus sp.: Mészáros 1972
Ancylis mitterbacheriana ([Denis – Schiffermüller], 1775)
Quercus petraea: Cs.Gy.
Quercus pubescens: Sz.Cs.
Quercus robur: Cs.Gy.
Archips crataegana (Hübner, 1799)
Quercus pubescens: Cs.Gy.
Archips podana (Scopoli, 1763)
Quercus petraea: Cs.Gy.
Archips rosana (Linnaeus, 1758)
Quercus petraea: Cs.Gy.
Archips xylosteana (Linnaeus, 1758)
Quercus cerris: Cs.Gy.
Quercus petraea: Szontagh 1973, Cs.Gy.
Quercus pubescens: Szontagh 1973, Cs.Gy., Sz.Cs.
Quercus robur: Cs.Gy.
Quercus rubra: Cs.Gy.
Choristoneura hebenstreitella (Müller, 1764)
Quercus pubescens: Herczig et al. 1980
Cydia amplana (Hübner, 1799)
Quercus cerris: Hirka, 2003
Quercus petraea: Hirka, 2003
Quercus pubescens: Hirka, 2003
Quercus robur: Hirka, 2003

- Cydia triangulella* (Goeze, 1783)
Quercus coccinea: Csóka – Hirka, 2002
Quercus frainetto: Hirka, 2003
Quercus ilicifolia: Hirka, 2003
Quercus palustris: Csóka – Hirka, 2002
Quercus petraea: Cs.Gy., Sz.Cs.
Quercus pubescens: Cs.Gy., Sz.Cs.
Quercus robur: Cs.Gy.
Quercus rubra: Csóka – Hirka, 2002
Quercus velutina: Hirka, 2003
Quercus sp.: Szöcs, 1963,
Epinotia festivana (Hübner, 1799)
Quercus pubescens: Cs.Gy.
Eudemis profundana ([Denis et Schiffermüller], 1775)
Quercus petraea: Cs.Gy.
Eulia ministrana (Linnaeus, 1758)
Quercus sp.: Razowski, 2001
Gypsonoma dealbana (Frölich, 1828)
Quercus sp.: Patočka et al 1999
Orthotaenia undulana ([Denis – Schiffermüller], 1775)
Quercus sp.: Patočka et al 1999
Pammene albuginana (Guenée, 1845)*
Quercus sp.: Razowski, 2001
Pammene amygdalana (Duponchel, 1843)*
Quercus cerris: Cs.Gy.
Quercus petraea: Cs.Gy.
Quercus pubescens: Cs.Gy.
Quercus robur: Cs.Gy.
Pammene fasciana (Linnaeus, 1761)
Quercus cerris: Hirka, 2003
Quercus petraea: Hirka, 2003
Quercus pubescens: Hirka, 2003
Quercus sp.: Szöcs, 1963,
Pammene gallicolana Lienig et Zeller, 1846*
Quercus petraea: Cs.Gy.
Quercus pubescens: Cs.Gy.
Quercus robur: Cs.Gy.
Pammene giganteana (Peyerimhoff, 1863)*
Quercus robur: Cs.Gy.
Pammene insulana (Guenée, 1845)*
Quercus sp.: Razowski, 2001
Pammene querceti (Gozmány, 1957)*
Quercus pubescens: Razowski, 2001
Pammene splendidulana (Guenée, 1845)
Quercus sp.: Patočka et al 1999
Pandemis cerasana (Hübner, 1796)
Quercus petraea: Cs.Gy.
Pandemis corylana (Fabricius, 1794)
Quercus petraea: Cs.Gy.
Pandemis heparana ([Denis – Schiffermüller], 1775)
Quercus petraea: Cs.Gy.
Paramesia gnomana (Clerk, 1759)
Quercus sp.: Patočka et al 1999
Pseudeulia asinana (Hübner, 1799)
Quercus sp.: Patočka et al 1999
- Ptycholoma lecheana* (Linnaeus, 1758)
Quercus petraea: Cs.Gy.
Strophedra nitidana (Fabricius, 1794)
Quercus sp.: Patočka et al 1999
Spilonota ocellana ([Denis – Schiffermüller], 1775)
Quercus sp.: Patočka et al 1999
Syndemis musculana (Hübner, 1799)
Quercus sp.: Patočka et al 1999
Tortricodes alternella ([Denis – Schiffermüller], 1775)
Quercus petraea: Cs.Gy.
Quercus pubescens: Sz.Cs.
Tortrix viridana Linnaeus, 1758
Quercus frainetto: Cs.Gy.
Quercus macranthera: Cs.Gy.
Quercus petraea: Szontagh 1973, Mészáros 1981, Cs.Gy., Sz.Cs.
Quercus pubescens: Cs.Gy., Sz.Cs.
Quercus robur: Cs.Gy.
Quercus sp.: Mészáros, 1972, 1974
Zeiraphera isertana (Fabricius, 1794)
Quercus petraea: Cs.Gy.
- Ypsolophidae**
Ypsolopha alpella ([Denis – Schiffermüller], 1775)
Quercus cerris: Patočka et al 1999
Quercus petraea: Cs.Gy.
Quercus pubescens: Cs.Gy.
Quercus sp.: Mészáros, 1972
Ypsolopha lucella (Fabricius, 1775)
Quercus sp.: Patočka et al 1999
Ypsolopha paranthesella (Linnaeus, 1767)
Quercus petraea: Patočka et al 1999
Ypsolopha sylvella (Linnaeus, 1767)
Quercus petraea: Cs.Gy.
Ypsolopha ustella (Clerk, 1759)
Quercus petraea: Sz.Cs.
Quercus pubescens: Sz.Cs.
- Zygaenidae**
Rhagades pruni ([Denis – Schiffermüller], 1775)
Quercus sp.: Patočka et al 1999

4 DISCUSSION

As can be seen in *Table 1*, 308 lepidopteran species belonging to 32 families are known to feed on oaks. In the case of 51.6 % (159 species) the authors present own original rearing data. Original Hungarian rearing data from literature are available for 30.2 % (93 species). In the case of 31.2% (96 species) records were obtained from foreign literature. Only one species of this 96 is covered by both Hungarian and foreign references. This is because the foreign reference records hostplants different from the one in the Hungarian reference. 69.2% of the 308 species (213 species) were put on the list based on original Hungarian data.

Table 1. Distribution of the data in the checklist according to their origin (number of species by families and origin of the data)

	Author's original data	Original Hungarian data	Foreign literature data	Total
<i>Arctiidae</i>	3	0	0	3
<i>Bucculatricidae</i>	0	1	0	1
<i>Chimabachidae</i>	1	0	0	1
<i>Coleophoridae</i>	1	5	0	6
<i>Cosmopterygidae</i>	0	0	1	1
<i>Cossidae</i>	2	0	0	2
<i>Drepanidae</i>	3	1	0	4
<i>Eriocraniidae</i>	0	0	1	1
<i>Gelechiidae</i>	2	0	6	8
<i>Geometridae</i>	30	5	28	63
<i>Gracillariidae</i>	5	14	0	16
<i>Heliozelidae</i>	0	1	0	1
<i>Incurvariidae</i>	0	1	0	1
<i>Lasiocampidae</i>	9	6	0	12
<i>Limacodidae</i>	1	0	1	2
<i>Lycaenidae</i>	2	1	0	2
<i>Lymantriidae</i>	9	8	0	11
<i>Nepticulidae</i>	2	17	3	21
<i>Noctuidae</i>	34	7	26	62
<i>Nolidae</i>	0	3	0	3
<i>Notodontidae</i>	13	4	0	15
<i>Oecophoridae</i>	1	0	0	1
<i>Pyralidae</i>	4	4	5	9
<i>Sessiidae</i>	2	0	2	4
<i>Sphingidae</i>	2	0	0	2
<i>Saturniidae</i>	3	1	0	3
<i>Thaumetopoeidae</i>	1	0	0	1
<i>Thyatiridae</i>	2	3	0	4
<i>Tischeriidae</i>	3	2	0	3
<i>Tortricidae</i>	20	7	17	39
<i>Ypsolophidae</i>	4	2	3	5
<i>Zygaenidae</i>	0	0	1	1
TOTAL	159	93	96	308

The numbers in the Total column do not necessary equal the sum of the numbers in the other 3 columns because some species can have data from more than one origin.

The presently listed species number exceeds the 292 species recorded by Csóka (1994, 1998) by 5.5% (16 species). In addition to the increase in the number of species, it is even more important that this list contains a much higher quantity of original rearing data. The information content and reliability of these data are much higher than in previous lists.

The 308 species is close to the 300 species (also including literature data) given by Patočka (1980), and significantly less than the 453 species given by Soria (1988) from Spain. But in case of the second reference the relative contributions of literature data and original data are not clear.

The main advantage of the original Hungarian data that in most case the exact species of hostplant is given, in contrast to foreign summarising works, which usually mention only *Quercus* as hostplant. This checklist gives considerable amount of data for the following 5 oak species. The numbers in brackets indicate the numbers given by Csóka (1994).

<i>Quercus cerris</i> :	65 (47)
<i>Quercus petraea</i> :	119 (67)
<i>Quercus pubescens</i> :	89 (45)
<i>Quercus robur</i> :	111 (68)
<i>Quercus rubra</i> :	16(6)

It means that during the last decade the number of species-level hostplant data has increased by more than 70 %.

Acknowledgement: The research on oak herbivore insects was supported by the OTKA T 034774 research grant.

REFERENCES

- CSÓKA, Gy. (1991): Macrolepidoptera hernyók tölgy tápnövényeinek hazai adatai [Oak foodplant data of Macrolepidoptera in Hungary]. Erdészeti Kutatások 82-83: 89-93 (in Hungarian)
- CSÓKA, Gy. (1994): Adalékok a hazai *Quercus*-fajok herbivor rovar guild-jének ismeretéhez [Data to knowledge on herbivore insect guild of *Quercus* species in Hungary]. Szakdolgozat -ELTE TTK posztgraduális zoológus szak. (in Hungarian)
- CSÓKA, Gy. (1996): Herbivor rovarok fajgazdagsága erdei fákon [Richness of herbivore insects of different forest trees]. In: Mátyás Cs. (ed.): Erdészeti ökológia. Mezőgazda Kiadó, Budapest. 184-186 (in Hungarian)
- CSÓKA, Gy. (1998): A Magyarországon honos tölgyek herbivor rovaregyüttese [Herbivore insects of oaks native in Hungary]. Erdészeti Kutatások 88: 311-318.
- CSÓKA, Gy. – HIRKA A. (2002): Adatok a Magyarországon nem őshonos tölgyeken megtelepedő herbivor rovarok ismeretéhez [Data on insects colonising exotic oaks in Hungary]. Erdészeti Kutatások, 90: 195-204 (in Hungarian)
- EMMET, A.M ed (1988): A field guide to the smaller british lepidoptera. British Entomological & Natural History Society
- FAJČIK, J. – SLAMKA, F. (1966): Die Schmetterlinge Mitteleuropas I
- GASTON, K. J. (1992). Regional numbers of insect and plant species. Functional Ecology 6: 243-247.
- HERCZIG, B. – RONKAY, L. – SZABÓKY, Cs. (1980): Data to the knowledge of natural foodplants of Lepidopterous larvae in Hungary Folia Entomologica Hungarica 33: 67-73.
- KARBAN, R. – RICKLEFS, R. E. (1984): Leaf traits and the species richness and abundance of Lepidopteran larvae on deciduous trees in southern Ontario. OIKOS 43: 165-170.

- KARBAN, R. – RICKLES, R.E. (1983): Host characteristics, sampling intensity, and species richness of lepidoptera larvae on broad-leaved trees in Southern Ontario. *Ecology* 64(4): 636-641.
- KENNEDY, J., E. C - SOUTHWOOD, R, T. (1984): The number of species of insects associated with British trees: a re-analysis. *Journal of Animal Ecology* 53: 455-478.
- KOCH, M. (1988): *Wir bestimmen Schmetterling*. Neumann Verlag
- LAŠTŮVKA, Z. – LAŠTŮVKA, A. (2001): *The Sessiidae of Europe*. Apollo Books, Stenstrup
- LEATHER, S.R. (1986). "Insect species richness of the british rosaceae: the importance of host range, plant architecture, age of establishment, taxonomic isolation and species-area relationships. *Journal of Animal Ecology* 55: 841-860.
- MÉSZÁROS, Z. (1969): Adatok a lepkehernyók természetes tápnövényeihez, különös tekintettel a lucernára (Data to the knowledge of natural foodplants of Lepidopterous larvae in Hungary with special regards to alfalfa]. *Folia Entomologica Hungarica* 22: 365-369 (in Hungarian)
- MÉSZÁROS, Z. (1972): Adatok a magyarországi lepkehernyók természetes tápnövényeihez (Lep.) II. [Data to the natural foodplants of Lepidopterous larvae in Hungary (Lep. II.)]. *Folia Entomologica Hungarica* 25: 473-480 (in Hungarian)
- MÉSZÁROS, Z. (1974): Adatok a magyarországi lepkehernyók természetes tápnövényeihez (Lepidoptera) III. [Data to the knowledge of natural foodplants of Lepidopterous larvae in Hungary (Lepidoptera) III]. *Folia Entomologica Hungarica* 27: 113-117 (in Hungarian)
- MÉSZÁROS, Z. (1981): Data to the knowledge of natural foodplants of lepidopterous larvae with special regard to the apple. *Folia Entomologica Hungarica* 42: 139-143.
- NEUVONEN, S. – NIEMELÄ, P. (1981):. Species richness of macrolepidoptera on Finnish deciduous trees and shrubs. *Oecologia* 51: 364-370
- NEUVONEN, S. – NIEMELÄ, P. (1983): Species richness and faunal similarity of arboreal insect herbivores. *OIKOS* 40: 452-459.
- NIKLOS, K. (1917): A *Phycis tumidella* (Zk.) károsítása a csertölgyön [Damage caused by *Phycis tumidella* (Zk.) on turkey oak]. *Erdészeti Lapok* 56: 349-350 (in Hungarian)
- PATOČKA, J. (1980): *Die Raupen und Puppen der Eichenschmetterlinge Mitteleuropas*. Monographs to *Journal of Applied Entomology*. Verlag Paul Parey
- PATOČKA, J. – KRIŠTIN A. – KULFAN J. - ZACH, P. (1999): *Die Eichenschädlinge und ihre Feinde*. Intitut für Waldökologie der Slowakischen Akademie der Wissenschaften, Zvolen
- SORIA, S. (1988): *Bolettin Sanidad Veget. Plagas* 14: 1-26.
- STRONG, D.R.J. – LEVIN, D.A. (1979): Species richness of plant parasites and growth form oh their hosts. *The American Naturalist* 114(1): 1-22.
- STUBNYA, V. (1955): Az *Acrobasis (Phycis) consociella* Hbn. (Lep. Pyral.) károsítása csereseinkben [Damage caused by *Acrobasis (Phycis) consociella* Hbn. (Lep. Pyral.) in turkey oak stands]. *Erdőmérnöki Főiskola Közleményei* 149-155 (in Hungarian)
- SZABÓKY, CS. (2002): Molyfaunisztikai újdonságok VI. [New data for the Hungarian Microlepidopteran fauna VI.] *Folia Entomologica Hungarica* 63: 197-200 (in Hungarian)
- SZENTKIRÁLYI, F. – KOZÁR, F. (1991). How many species are there in apple insect communities?: testing the resource diversity and intermediate disturbance hypotheses. *Ecological Entomology* 16: 491-503.
- SZEŐKE, K. (1982): Data to the foodplants of lepidopterous larvae in Hungary. *Folia Entomologica Hungarica* 43 (1): 169-173.
- SZŐCS, J.(1963): A lepkehernyók természetes tápnövényei [Natural foodplants of lepidopterous larvae]. *Folia Entomologica Hungarica* 16: 83-120 (in Hungarian)
- SZŐCS, J. (1971): A lepkehernyók természetes tápnövényei II [Natural foodplants of lepidopterous larvae II.]. *Folia Entomologica Hungarica* 24: 443-463 (in Hungarian)
- SZŐCS, J. (1977): A lepkehernyók természetes tápnövényei III. [Natural foodplants of lepidopterous larvae III]. *Folia Entomologica Hungarica* 30: 143-150 (in Hungarian)
- TALLÓS, P. (1961): Hazai nagylepkek hernyóinak természetes tápnövényei. [Natural foodplants of the Macrolepidopteran larvae in Hungary]. *Folia Entomologica Hungarica* 14: 413-422 (in Hungarian)

Local Variability of Electric Potential Differences on the Trunk of *Quercus cerris* L.

András KOPPÁN*, László SZARKA, Viktor WESZTERGOM

Geodetic and Geophysical Research Institute of Hungarian Academy of Sciences
and Institute of Geosciences, University of West Hungary, Sopron, Hungary

Abstract – Electric potential differences (EPD) had been continuously recorded for four years from 1997 until 2001 between electrodes inserted in sixteen selected sites of the trunk of a turkey oak (*Quercus cerris* L.). In our earlier paper (Koppán et al. 2000), by using this method we revealed the annual variation of amplitudes of diurnal sap-flow fluctuation. In this paper a comparative analysis is carried out in order to study the local variability of sap-flow within the trunk. Values of EPDs were compared at four different height levels and four different exposures of the trunk. A significant difference can be shown between the channels of Eastern and Western side, while the deviations between the height levels are slight. The most likely reason for the differences between the channels is structural inhomogeneity.

electric potential difference / *Quercus cerris* / bioelectricity

Kivonat – Elektromos potenciálkülönbségek lokális változása *Quercus cerris* L. törzsén. 1997-től négy éven keresztül mértünk elektromos potenciálkülönbségeket egy csertölgy (*Quercus cerris* L.) törzsébe ültetett tizenhat elektród segítségével. Egy korábbi dolgozatban (Koppán et al. 2000) kimutattuk a napi fánedv-áramlás amplitúdójának éves változásait. Ebben a tanulmányban az egyes csatornák összehasonlító elemzését mutatjuk be. Azt vizsgáljuk, hogy az elektromos potenciálkülönbségek (EPD) a fatörzs négy magasságszintjén, és a négy égtáj szerint hogyan különböznek egymástól. Szignifikáns különbség mutatható ki a keleti és nyugati oldal csatornái között, míg a szintek szerinti különbség csekélynek mondható. A csatornák közt tapasztalt különbségek legvalószínűbb oka a fatörzs szerkezeti inhomogenitása.

elektromos potenciálkülönbség / csertölgy / bioelektromosság

1 INTRODUCTION

Bioelectric phenomena at tissue and organism level are sometimes less known in plants than in animals, although the problem of plants seems to be simpler than that of animals or humans. Electrical measurements on plants especially on trees have proven to be very difficult. Investigation of bioelectric phenomena of trees became widespread at first in the fifties and sixties (e.g. Fensom 1962), then in the early '90s, when automatic measuring techniques became available. One of such studies was the experiment carried out by Morat et al. (1994) at the Earth Physics Institute of Paris. (This experiment was motivated

* Corresponding author: koppan@ggki.hu; H-9400 SOPRON, Csatai u. 6-8.

merely by geophysical considerations. Namely, that the natural telluric field is strongly distorted in the vicinity of trees.)

Our first project on this subject (in 1995) was a direct adaptation of the French experiment (Koppán et al. 1999). Based on these experiments we planned a new research which was started in 1997. We continuously measured electric potential differences (EPD) by using electrodes inserted into the sapwood of turkey oaks (*Quercus cerris* L.) for four years. The experiment was completed later with a direct measurement of sap-flow by using Granier's radial flowmeter technique (Granier 1987). Most important environmental parameters such as temperature, air humidity, atmospheric electricity, geomagnetic and geoelectric field were also recorded.

The main purpose of this research was the investigation of the temporal and spatial variations of electric potential differences measured on the tree trunk. After determining the variations of the electric potential differences and their characteristics the next step was to define which internal processes and environmental parameters might be the source for the formation and changes of the electric potential differences. On the basis of the correlation between EPD and sap-flow, a new sap-flow monitoring method can be developed.

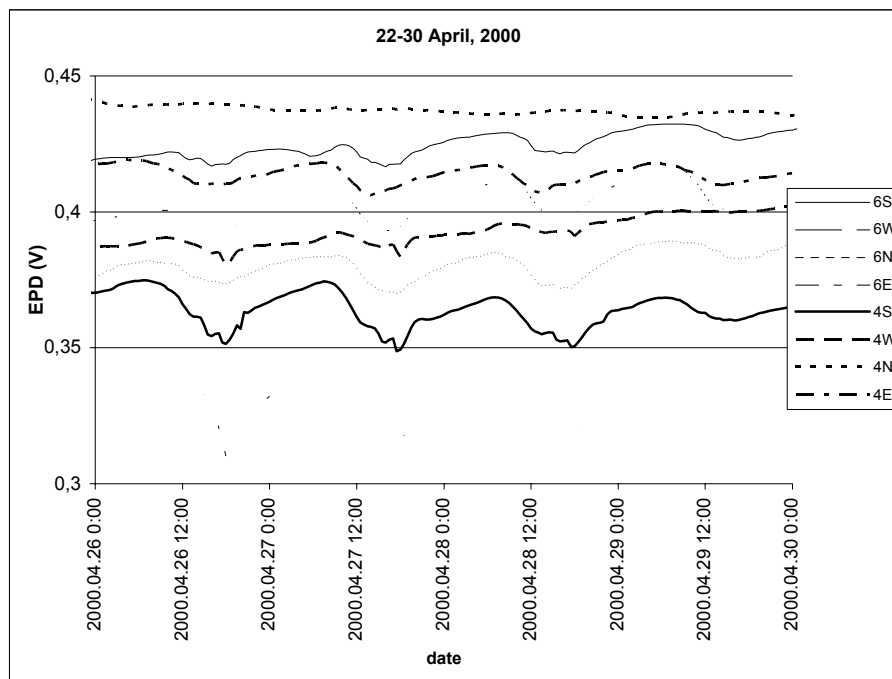

Figure 1. Sample data series of measured EPDs (26-30. April, 2000).

Previously we observed characteristic daily variations (Figure 1) and an annual fluctuation of the mean amplitude of these diurnal variations (Koppán et al. 2000a). We found a remarkable correlation between EPD and the sap flux density data, indicating, that sap streaming due to transpiration and root pressure generates the largest part of measured potential differences (Koppán et al. 2000b, Koppán et al. 2002). In all these papers the measuring channels were considered together. Their mean value was used to determine the typical behavior. Although the general characteristics of the observed daily variations are similar for each channel, there are slight differences between them.

In the present paper we investigate the spatial variations of EPDs, namely how the EPDs measured by single channels differ from each other, how significant these differences are, and whether some regularity in these differences is discoverable or not. We also investigate how the position (height, exposure) of electrodes – independently of other factors – can affect the EPDs.

2 MATERIALS AND METHODS

The EPD measurement were started in the “Széchenyi István” Geophysical Observatory of Hungarian Academy of Sciences, on 14 July, 1997. As shown in *Figure 2*, sixteen non-polarizing electrodes were inserted beneath the cambium into the sapwood of a turkey oak (*Quercus cerris* L.) at four height levels (at 0, 2, 4 and 6 m), and at each height level four electrodes (corresponding to S, W, N and E sides of the tree) were installed. The EPDs were measured between the trunk electrodes and a common ground. The sampling interval was kept as short as 1 sec, and 1 minute mean values were continuously recorded.

In order to determine the local variability of EPD on the trunk, we carried out a comparative analysis, by using four time intervals, each of them lasting several months (*Table 1*). As a first step we computed the Pearson's correlation coefficients (see formula 1) between each possible pairs of the 16 measuring channels (*Tables 3-6*).

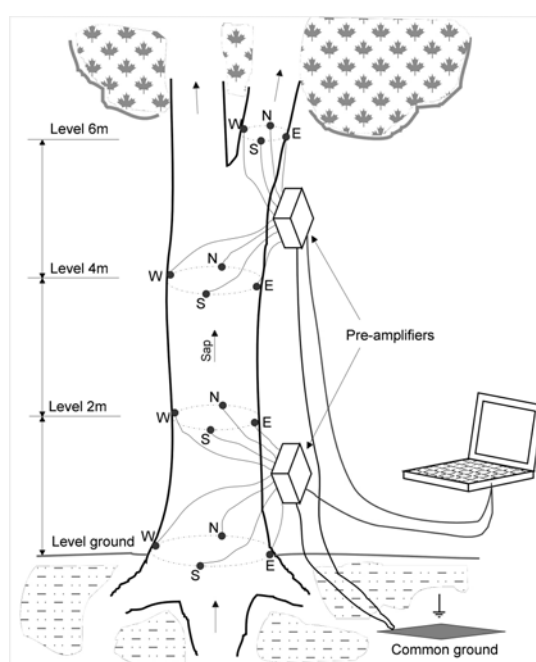

Figure 2. The EPD measuring system

$$\rho_{x,y} = \frac{\text{cov}(x,y)}{\sigma_x \cdot \sigma_y} = \frac{\frac{1}{n} \sum_{i=1}^n (x_i - \bar{x})(y_i - \bar{y})}{\sqrt{\frac{1}{n} \sum_{i=1}^n (x_i - \bar{x})^2} \cdot \sqrt{\frac{1}{n} \sum_{i=1}^n (y_i - \bar{y})^2}} \quad (1)$$

Table 1. Time intervals for correlation analysis (sampling interval=30 min)

Sample number	Date	Data number/channel
1	07 May – 21 November, 1998	9532
2	16 January – 31 May, 1999	6528
3	15 July – 31 December, 2000	7776
4	01 January – 16 May, 2001	6528

Correlation matrices give information only on the overall relationship between channels. In order to study possible time processes, a time delay study was also carried out. Thus, as a next step we investigated the effect of the exposure and of the height of electrodes on the time series of EPD daily variations. For this purpose eight (at least six day long) time intervals having sunny and undisturbed weather conditions were selected (*Table 2*).

Table 2. Time intervals for investigation of the effect of the exposure (sampling interval=1 min)

Sample number	Date	Data number/channel
5	07-15 May, 1998	12960
6	08-20 August, 1998	18720
7	01-07 April, 1999	10080
8	12-20 September, 1999	12960
9	22-30 April, 2000	12960
10	10-21 August, 2000	17280
11	23-30 April, 2001	11520
12	14-19 August, 2001	8640

3 RESULTS

3.1 Correlation coefficients between any two ones of the 16 channels

Pearson's coefficients are shown for the time intervals 1, 2, 3, and 4 in *Table 3, 4, 5 and 6*. It is clearly seen that a strong correlation exists between different height levels and between different exposures, but the correlation values are not constant with time.

Table 3. Pearson's correlation coefficients of the 16 channels (07 May – 21 November, 1998)

	6S	6W	6N	6E	4S	4W	4N	4E	2S	2W	2N	2E	0S	0W	0N	0E
6S	1															
6W	.843*	1														
6N	.721*	.679*	1													
6E	.748*	.698*	.555*	1												
4S	.369*	.386*	.425*	.266*	1											
4W	.080*	.093*	.252*	.089*	.871*	1										
4N	.575*	.506*	.366*	.457*	.648*	.375*	1									
4E	.254*	.314*	.310*	.381*	.812*	.740*	.566*	1								
2S	.508*	.395*	.358*	.250*	-.734*	-.720*	-.094*	-.767*	1							
2W	.123*	.109*	.318*	-.118*	-.580*	-.406*	-.662*	-.696*	.699*	1						
2N	.235*	.131*	.336*	-.098*	-.482*	-.454*	-.255*	-.575*	.589*	.661*	1					
2E	.225*	.256*	.349*	-.026*	-.537*	-.472*	-.400*	-.611*	.651*	.826*	.602*	1				
0S	.558*	.521*	.324*	.353*	-.399*	-.690*	.497*	-.249*	.469*	.096*	.364*	.376*	1			
0W	.235*	.207*	.443*	.119*	-.439*	-.356*	-.517*	-.425*	.573*	.800*	.722*	.740*	.282*	1		
0N	.398*	.292*	.287*	.101*	-.703*	-.760*	.007*	-.693*	.771*	.602*	.731*	.701*	.691*	.624*	1	
0E	.331*	.270*	.322*	.099*	-.523*	-.538*	-.083*	-.577*	.676*	.629*	.692*	.757*	.640*	.710*	.823*	1

* Correlation is significant at the 0.01 level (2-tailed).

N=9532/channel

Table 4. Pearson's correlation coefficients of the 16 channels (16 January – 31 May, 1999)

	6S	6W	6N	6E	4S	4W	4N	4E	2S	2W	2N	2E	0S	0W	0N	0E
6S	1															
6W	.923*	1														
6N	.941*	.890*	1													
6E	.953*	.891*	.877*	1												
4S	.561*	.564*	.631*	.437*	1											
4W	.207*	.238*	.135*	.184*	.386*	1										
4N	-.076*	-.241*	.041*	-.054*	.025**	-.189*	1									
4E	.862*	.893*	.782*	.828*	.462*	.442*	-.340*	1								
2S	.926*	.899*	.930*	.839*	.728*	.248*	-.101*	.806*	1							
2W	.956*	.939*	.941*	.886*	.638*	.266*	-.149*	.883*	.962*	1						
2N	.817*	.787*	.881*	.732*	.765*	.210*	.084*	.675*	.892*	.868*	1					
2E	.938*	.917*	.911*	.898*	.604*	.247*	-.110*	.841*	.931*	.958*	.863*	1				
0S	.819*	.760*	.834*	.783*	.473*	-.139*	.090*	.624*	.766*	.795*	.724*	.817*	1			
0W	.849*	.872*	.828*	.842*	.269*	.088*	-.111*	.824*	.762*	.841*	.629*	.830*	.769*	1		
0N	.682*	.602*	.741*	.680*	.380*	-.250*	.332*	.423*	.620*	.636*	.664*	.676*	.875*	.675*	1	
0E	.684*	.633*	.737*	.683*	.512*	-.106*	.256*	.494*	.676*	.689*	.746*	.709*	.807*	.598*	.878*	1

* Correlation is significant at the .01 level (2-tailed).

** Correlation is significant at the .05 level (2-tailed).

N=6528/channel

Table 5. Pearson's correlation coefficients of the 16 channels (15 July – 31 December, 2000)

	6S	6W	6N	6E	4S	4W	4N	4E	2S	2W	2N	2E	0S	0W	0N	0E
6S	1															
6W	.139*	1														
6N	.789*	-.224*	1													
6E	.680*	-.372*	.919*	1												
4S	.847*	-.103*	.902*	.848*	1											
4W	.822*	.333*	.661*	.525*	.695*	1										
4N	.733*	-.092*	.867*	.785*	.857*	.659*	1									
4E	.907*	.163*	.792*	.654*	.853*	.891*	.783*	1								
2S	.869*	.067*	.822*	.744*	.906*	.810*	.809*	.905*	1							
2W	.811*	.353*	.657*	.523*	.736*	.866*	.648*	.855*	.842*	1						
2N	.915*	.059*	.859*	.755*	.909*	.828*	.834*	.949*	.935*	.842*	1					
2E	-.157*	.785*	-.422*	-.525*	-.304*	.036*	-.292*	-.125*	-.150*	.165*	-.189*	1				
0S	.902*	.069*	.825*	.750*	.899*	.820*	.795*	.912*	.920*	.821*	.926*	-.189*	1			
0W	.471*	.034*	.710*	.613*	.609*	.541*	.652*	.516*	.566*	.627*	.578*	-.007	.596*	1		
0N	.652*	.216*	.674*	.595*	.725*	.712*	.703*	.732*	.766*	.810*	.775*	.115*	.745*	.768*	1	
0E	.847*	.088*	.832*	.755*	.872*	.847*	.797*	.879*	.914*	.867*	.894*	-.125*	.915*	.688*	.837*	1

* Correlation is significant at the 0.01 level (2-tailed).

N=7776/channel

Table 6. Pearson's correlation coefficients of the 16 channels (01 January – 16 May, 2001)

	6S	6W	6N	6E	4S	4W	4N	4E	2S	2W	2N	2E	0S	0W	0N	0E
6S	1															
6W	.641*	1														
6N	.708*	.732*	1													
6E	.796*	.710*	.925*	1												
4S	.698*	.692*	.892*	.879*	1											
4W	.682*	.861*	.662*	.684*	.641*	1										
4N	.446*	.802*	.717*	.663*	.714*	.781*	1									
4E	.487*	.742*	.756*	.698*	.684*	.720*	.768*	1								
2S	.335*	.033**	.370*	.390*	.441*	.044*	.209*	.094*	1							
2W	.454*	.646*	.549*	.518*	.619*	.586*	.686*	.590*	.326*	1						
2N	.528*	.548*	.798*	.738*	.849*	.460*	.634*	.549*	.567*	.586*	1					
2E	.442*	.844*	.563*	.532*	.560*	.724*	.811*	.649*	.129*	.708*	.499*	1				
0S	.484*	.651*	.703*	.630*	.727*	.625*	.716*	.669*	.299*	.608*	.655*	.570*	1			
0W	.626*	.824*	.658*	.634*	.704*	.839*	.755*	.625*	.149*	.648*	.579*	.686*	.756*	1		
0N	.455*	.804*	.559*	.506*	.601*	.802*	.766*	.673*	.002	.634*	.465*	.735*	.751*	.841*	1	
0E	-.187*	-.141*	-.422*	-.419*	-.386*	.030**	-.079*	-.174*	-.061*	.057*	-.291*	.011	-.047*	.028**	.141*	1

* Correlation is significant at the .01 level (2-tailed).

** Correlation is significant at the .05 level (2-tailed).

N=6528/channel

Two different, compact presentations of the correlation relationships are shown in *Tables 7 and 8*. In *Table 7* correlation matrices are shown for the four different height levels (when the mean value of exposures is considered), while in *Table 8* correlation coefficients are shown between any two exposures (N, E, S and W), when the height of electrodes is eliminated by the mean value of the corresponding channels. The correlation is strong between levels 0m and 2m, and also between 4m and 6m. Other coefficients may be small and sometimes change sign.

Table 7. Correlation between mean of the level-averages

Sample 1 (07 May – 21 November, 1998)					Sample 3 (15 July – 31 December, 2000)				
	6m_avg	4m_avg	2m_avg	0m_avg		6m_avg	4m_avg	2m_avg	0m_avg
6m_avg	1				6m_avg	1			
4m_avg	0.413	1			4m_avg	0.941	1		
2m_avg	0.290	-0.666	1		2m_avg	0.844	0.912	1	
0m_avg	0.390	-0.336	0.797	1	0m_avg	0.904	0.921	0.899	1

Sample 2 (16 May – 21 November, 1999)					Sample 4 (01 January – 16 May, 2001)				
	6m_avg	4m_avg	2m_avg	0m_avg		6m_avg	4m_avg	2m_avg	0m_avg
6m_avg	1				6m_avg	1			
4m_avg	0.755	1			4m_avg	0.894	1		
2m_avg	0.955	0.797	1		2m_avg	0.750	0.762	1	
0m_avg	0.888	0.556	0.846	1	0m_avg	0.680	0.813	0.663	1

Table 8. Correlation between mean values of exposures

Sample 1 (07 May – 21 November, 1998)					Sample 3 (15 July – 31 December, 2000)				
	S_avg	W_avg	N_avg	E_avg		S_avg	W_avg	N_avg	E_átl
S_avg	1				S_avg	1			
W_avg	0.666	1			W_avg	0.763	1		
N_avg	0.900	0.644	1		N_avg	0.946	0.75	1	
E_avg	0.813	0.693	0.760	1	E_avg	0.954	0.823	0.956	1

Sample 2 (16 May – 21 November, 1999)					Sample 4 (01 January – 16 May, 2001)				
	S_avg	W_avg	N_avg	E_avg		S_avg	W_avg	N_avg	E_avg
S_avg	1				S_avg	1			
W_avg	0.907	1			W_avg	0.084	1		
N_avg	0.907	0.787	1		N_avg	0.835	0.408	1	
E_avg	0.943	0.946	0.866	1	E_avg	0.308	0.874	0.626	1

3.2 EPD time delays between different height levels and exposures

The maximum values of the daily curves of EPDs occur normally around 6-7 a.m., while the minimum values are in the afternoon, somewhere around 16-17 hours (*Figure 3*). Usually the eastern channels reach the maximum first (6:32±43 min). They are followed by the northern, western and southern channels (6:54±26, 7:06±20 and 7:11±26 min respectively). In the afternoon hours the eastern channels reach the minimum at first (15:09±34 min), followed by the southern and northern channels (16:22±51 and 16:28±43 min respectively). In the afternoon it is the western side of the tree where the EPD has the largest time delay (17:29±09 min).

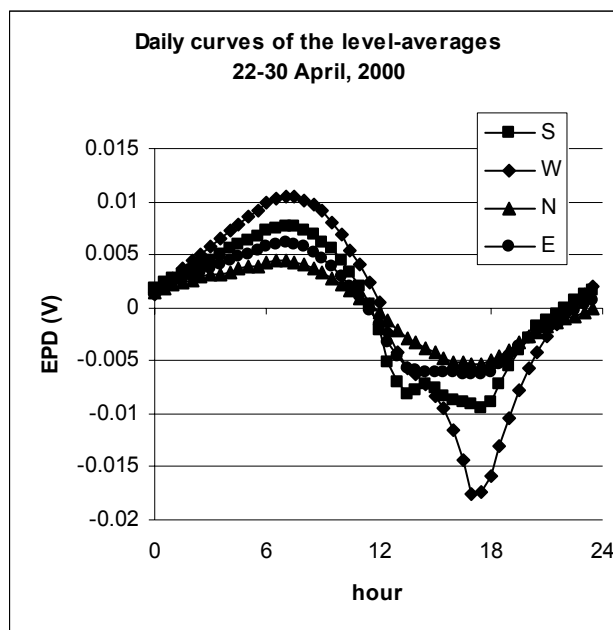

Figure 3. Typical daily EPD curves: four different height-averaged exposures.
Time interval: 22-30 April, 2000

Table 9. Time of maximum and minimum positions as a function of exposure
(The values marked with * were considered as distorted and therefore they were not taken into consideration)

Sample	Maximum position (hours)				Minimum position (hours)			
	S_max	W_max	N_max	E_max	S_min	W_min	N_min	E_min
5	0:00*	6:32	6:28	6:09	16:23	17:16	17:26	12:23*
6	6:30	0:35*	6:05	5:36	16:27	17:27	15:59	14:01
7	7:28	7:40	7:55	7:50	13:11*	17:56	16:43	15:21
8	8:19	7:48	7:41	7:44	17:28	17:28	14:18	15:24
9	7:00	6:59	7:06	7:04	17:36	17:11	17:19	14:50
10	6:49	6:54	6:46	5:35	16:57	17:33	16:01	14:57
11	6:59	7:04	6:46	5:06	14:29	17:27	17:17	12:45*
12	7:18	6:48	6:30	7:12	15:14	17:39	16:44	16:21
Average	7:11	7:06	6:54	6:32	16:22	17:29	16:28	15:09
St. deviation	0:35	0:27	0:37	1:03	1:08	0:13	1:02	0:46
Conf. interval ($\alpha=0.05$)	0:26	0:20	0:26	0:43	0:51	0:09	0:43	0:34

In Table 10 the effect of height levels is shown. Although it can be shown that on average the channels at the 4m height level arrive to their maximum and minimum values first ($6:55 \pm 19$ and $17:05 \pm 27$ min respectively) and the channels at the 6m height level reach the minima last ($17:31 \pm 27$ min), the deviations are not fundamentally significant between the height levels.

Table 10. Time of maximum and the minimum position as a function of height level
(The values marked with * were considered as disturbed, and therefore they were not taken into consideration)

Sample	Maximum position (hour)				Minimum position (hour)			
	6m_max	4m_max	2m_max	0m_max	6m_min	4m_min	2m_min	0m_min
5	7:31	6:57	2:56*	2:34*	17:42	16:18	17:12	17:11
6	6:43	6:21	23:41*	23:37*	16:36	16:06	17:01	6:39*
7	7:55	7:32	7:43	7:57	18:06	17:34	17:42	17:37
8	8:58	7:03	8:15	23:48*	17:54	17:28	0:45*	0:56*
9	8:14	7:37	7:10	6:23	18:05	18:04	17:12	17:11
10	5:39	6:49	6:43	7:36	17:35	16:57	17:33	17:29
11	6:21	6:21	7:35	7:38	11:12*	17:04	17:24	17:30
12	6:31	6:42	7:24	7:45	16:45	17:10	17:12	16:41
Average	7:14	6:55	7:28	7:27	17:31	17:05	17:19	17:16
St. deviation	1:06	0:28	0:31	0:37	0:36	0:38	0:14	0:20
Conf. interval ($\alpha=0.05$)	0:46	0:19	0:24	0:29	0:27	0:27	0:10	0:15

4 DISCUSSION

In our earlier papers we proved that the EPD curves show characteristic daily fluctuations, and their amplitudes have a characteristic annual variation. By means of direct sap-flow measurement we also proved that these EPDs are connected to the sap-flow.

The electric potential differences, measured at different levels and directions, are similar. However, there are some differences. Correlation analysis based on four, 16-channel data sequences gathered over a few months show that the most likely reason for the differences between the channels is structural inhomogeneity. As a null-hypothesis we assumed that same quantity of sap flows across any chosen cross-section of the trunk. The path and sap-flow density can vary in the sap-wood (the individual xylem vessels transport different quantities of sap). The hydroactive xylem section is very thin, practically a few rings of cells (Granier et al. 1994), and it is very susceptible to embolization and cavitation. Observations showed that the transportation goes on in a very complex, three-dimensional network, in the direction of the lowest hydraulic resistance. (In this system the hydraulic resistance can be affected by many factors, such as temperature, ion content of the transported sap, mechanical damage, etc.) This hypothesis is confirmed by the fact that based on the correlation analysis we could not find any regularity in the deviations between the channels in the four years of the experiment. The correlations of the channels change from year to year and this presumes a yearly varying effect, which is the altering of the xylem-structure by the nascent annual rings.

The studies carried out for the determination of differences depending on the position of the electrodes (level and direction) show that the channels on the eastern side reach the maximum and the minimum values the earliest and the channels of the western side reach the minimum values the latest. There is no significant difference between the southern and northern channels. The differences cannot be fully explained by the exposure and unfortunately it was not possible investigate the structural inhomogeneity.

Some details of the observed phenomena still remain unexplained. In the future we plan to study the external effect on EPD measurements in details.

Acknowledgement: We wish to thank János Pongrácz, Gyula Pála and János Túri for their technical assistance.

REFERENCES

- FENSOM, D.S. (1962): The bioelectric potentials of plants and their functional significance IV. *Canad. J. of Botany* 40: 405-413.
- GRANIER, A. (1987): Mesure du flux de seve brute dans le tronc du Douglas par une nouvelle methode thermique. *Ann. Sci. For.* 44: 1-14.
- GRANIER, A. – ANFODILLO, T. – SABATTI, M. – COCHARD, H. – DREYER, E. – TOMASI, M. – VALENTINI, R. – BRÉDA, N. (1994): Axial and radial water flow in the trunks of oak trees: a quantitative and qualitative analysis. *Tree Physiology* 14: 1383-1396.
- KOPPÁN, A. – FENYVESI, A. – SZARKA, L. – WESZTERGOM, V. (2002): Measurement of electric potential difference on trees. *Acta Biologica Szegediensis* 46 (3-4): 37-38.
- KOPPÁN, A. – SZARKA, L. – WESZTERGOM, V. (1999): Temporal variation of electric signal recorded in a standing tree. *Acta Geod. Geoph. Hung.* 34(1-2), 169-180.
- KOPPÁN, A. – SZARKA, L. – WESZTERGOM, V. (2000 a): Annual fluctuation in amplitudes of daily variations of electrical signals measured in the trunk of a standing tree. *C. R. Acad. Sci. Paris, Sciences de la vie/ Life sciences* 323: 1-5.
- KOPPÁN, A. – SZARKA, L. – WESZTERGOM, V. (2000 b): Élő fa életfolyamatainak tükröződése a törzsön mért elektromos potenciálkülönbségekben [The reflecting of the life functions of trees in the electric potential differences measured on the trunk]. *Soproni Egyetem Tudományos Közleményei* 46: 17-23. (in Hungarian)
- MORAT, P. – LE MOUËL, J-L. – GRANIER, A. (1994): Electrical potential on tree. A measurement of the sap flow? *C. R. Acad. Sci. Paris, Sciences de la vie/ Life sciences* 317: 98-101.

Changes in the DRIFT Spectra of Softwood Irradiated by UV-laser as a Function of Energy

Edít BARTA^a – György PAPP^{a,d*} – Edina PREKLET^a – László TOLVAJ^a,
Ottó BERKESI^b – Tamás NAGY^c – Sándor SZATMÁRI^c

^a Institute of Physics, University of West Hungary, Sopron, Hungary

^b Department of Physical Chemistry, University of Szeged, Hungary

^c Department of Experimental Physics, University of Szeged, Hungary

^d Department of Theoretical Physics, University of Szeged, Hungary

Abstract – We investigated energy dependence of the effect of UV-laser irradiation on the DRIFT spectra of softwood samples. Changes in the spectra of softwoods have been studied with 248.5 nm wavelength of UV-laser radiation. To monitor the energy dependence, different number of laser impulses were directed towards the sample's surface. The dependence on energy of different bands can be listed into four groups. Broad absorption bands, which belong to the same chemical groups located at various positions, do not show consistent changes due to the absorption of different energy doses. The intensity of OH bands for the treated samples can be higher or lower depending on the amount of radiation energy. In the CH_n and in the band of non-conjugated carbonyl groups only absorption increase can be observed. Bands resulting from only one chemical component, and containing no other absorption maxima around them, uniformly decreased. The regions where the band of a chemical component lies next to another one, showed no consistent changes during the irradiation. The initial decrease was followed by increase.

softwood / UV laser / irradiation / energy dependence / degradation / DRIFT spectroscopy

Kivonat – UV-lézerrel besugárzott fenyő faanyag DRIFT spektrumának változása az energia függvényében. Fenyő faanyag DRIFT spektrumán vizsgáltuk UV-lézer besugárzással az energia függést. Az anyag spektrumának változását 248,5 nm hullámhosszú lézer sugárzásával idéztük elő. Az energiafüggés vizsgálatához változtattuk a minták felületére irányított lézerimpulzusok számát. Az energiafüggés szerint a különböző sávok négy csoportba sorolhatók. Azon széles sávok, amelyek az anyagot alkotó, különböző pozíciókban elhelyezkedő azonos kémiai csoportokhoz tartoznak, nem mutatnak egységes változást. A kezelt minták OH sávjainak intenzitása nőtt vagy csökkent, a sugárzás energiájának mennyiségétől függően. A CH_n és a nem konjugált karbonil csoportokhoz tartozó sávok abszorpciója nőtt. Azon sávok abszorpciója csökkent, amelyek egyetlen kémiai alkotótól származnak és környezetükben nem található más abszorpciós maximum. Azon tartományokban, ahol valamely kémiai komponens sávja mástól származó sáv közelében fekszik, alacsony energián csökkenés, magas energián növekedés következett be.

fenyő faanyag / UV-lézer / besugárzás / energiafüggés / degradáció / DRIFT spektroszkópia

* Corresponding author: gypapp@fmk.nyme.hu; H-9401 SOPRON, Pf. 132

1 INTRODUCTION

The surface of wood exposed to elements becomes gray, rough and stringy. It loses not only the usual appearance, but also its mechanical properties, even the strength characteristics degrade. As a consequence its admissible load decreases and its functional characteristics are limited. The damages caused by exposure are called degradation processes. There are several factors determining degradation processes: sun radiation, rain, temperature fluctuation, air humidity, fungi and insects. Among them the ultraviolet (UV) radiation of the sun is the most important in the degradation of the wood's surface. The study of the UV-photodegradation of wood began some decades ago (Kalinins 1966; Hon – Chang 1984). The investigation has two steps: first irradiating the wood's surface by an UV beam and detecting the changes caused by the radiation. There are two ways of irradiation: in a natural environment using the sun as a source, or in artificial circumstances, with different kinds of UV lamps. Neither in a natural environment, nor with traditional UV lamp (Xenon and mercury vapor lamps) experiments, is there a precise way to measure the energy of radiation on the sample's surface. In addition, UV-photodegradation is influenced by other factors (moisture, temperature, visible light and infrared radiation) that are hard to exclude. Using UV-laser instead of traditional lamps during the irradiation could solve all of the above-mentioned problems. Using lasers as radiation sources (Barta et al. 1998; Papp et al. 2001) the duration of the treatment can be shortened, the wavelength of the radiation is known, and the energy can be determined, as well as the intensity of radiation at the surface. In order to investigate the UV photo degradation's dependence on radiation energy, we used UV laser working at definite wavelengths. The infrared (IR) spectrum of wood has already been studied in many respects (Hess 1952; Marton – Sparks 1967; Michell 1988). The diffuse reflection infrared Fourier transform (DRIFT) spectroscopy is a widely accepted method of analyzing the spectrum of wood, wood components and pulp, and of monitoring the changes occurring on the surface of the wood (Hon 1994; Schultz – Glasser 1986; Dirckx et al. 1987; Michell 1988; Owen – Thomas 1989; Zavarin et al. 1990; Backa – Brolin 1991; Tylli et al. 1993; Pandey – Theagarajan 1997; Košíková – Tolvaj 1998; Barta et al. 1999; Papp et al. 1999; Papp et al. 2004). The energy dependence on changes in the absorption spectra of softwood materials will be discussed below.

2 MATERIAL AND METHODS

For the experiments the specimens were manufactured from softwood (larch, Scotch pine). Samples used were disks with 12 mm diameter and 1-2 mm thickness. Their surface contained only one type of tissue (early- or latewood of heartwood or sapwood). To attain uniform moisture content, the samples were dried at 70-75 °C during 3 days. Irradiation by UV-light was performed using a Krypton-Fluoride excimer laser. The schematic arrangement of experiments is shown in *Figure 1*.

The laser emitted light impulses with a wavelength of 248.5 nm and with a duration of 15 ns/impulse. The high energy of the impulses was reduced using an energy filter and the specimens were positioned with their surfaces perpendicular to the laser beam. The beam was made divergent using a quartz lens with a focal length of –10 cm, so the light reached the sample surface homogeneously. The detector of the energy-measuring instrument was placed immediately behind the sample holder, so exclusively the energy that passed through the hole of the holder was measured. Further increasing the distance between the lens and the sample holder can diminish the energy reaching the sample. This distance and the energy filter were

set so that the sample should receive 20 mJ energy /impulse. Each sample was repeatedly irradiated; their IR spectra were recorded after every irradiation phase. Each sample was irradiated by 2000 pulses per phase, at 10 Hz repetition rate, so each sample received 40 J energy in each phase. This is equivalent to an area energy density of 510 kJ/m². The irradiation was carried out at atmospheric pressures and in an open space. No cooling was used on the sample surface.

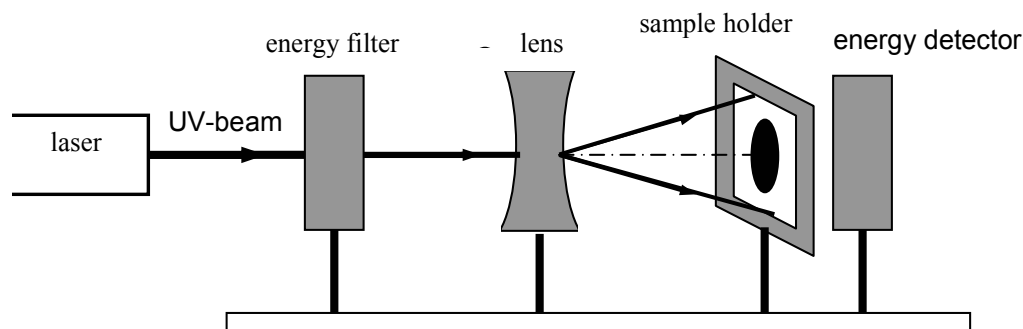

Figure 1. The schematic arrangement of irradiation setup

DRIFT spectra were recorded between 3800 and 850 cm⁻¹ with 4 cm⁻¹ resolution by using a Fourier-transform infrared (FTIR) spectrophotometer (Bio-Rad Digilab Division FTS-65A), modified according to our needs. Base-line correction was performed in two steps: between 3800 and 1900 cm⁻¹ and 1900 and 850 cm⁻¹.

Changes caused by the UV irradiation in the chemical structure of wood samples were investigated by analyzing the difference spectra obtained by subtracting the appropriate spectrum (measured in Kubelka-Munk unit (Kubelka 1948; Kubelka 1954)) of untreated samples from the spectrum (measured in Kubelka-Munk unit) of treated samples. It is important that the absorbance be constant at wave number values where there is no change in the spectrum. On the basis of earlier studies (Barta et al. 1988) the absorbance maximum at around 1373 cm⁻¹ was chosen as such a reference point. Each spectrum taken after UV treatment was multiplied by the factor obtained as the ratio of the absorbance at 1373 cm⁻¹ measured before and after UV irradiation. Thus the intensity value on the difference spectra is also given in Kubelka-Munk unit. Positive and negative values refer to an increase and a decrease in absorbance, respectively.

3 RESULTS AND DISCUSSION

To reveal the qualitative features of the spectra and its changes, the spectra of the earlywood of larch's heartwood, for untreated samples and those treated with 8000 impulses, are shown in *Figure 2*. The relevant peak wave numbers are also indicated.

For the analysis of the change in spectra caused by the irradiation, the difference spectra were divided into two regions:

- 1) Spectra between 3800 and 1800 cm⁻¹, and
- 2) Spectra between 1800 and 850 cm⁻¹.

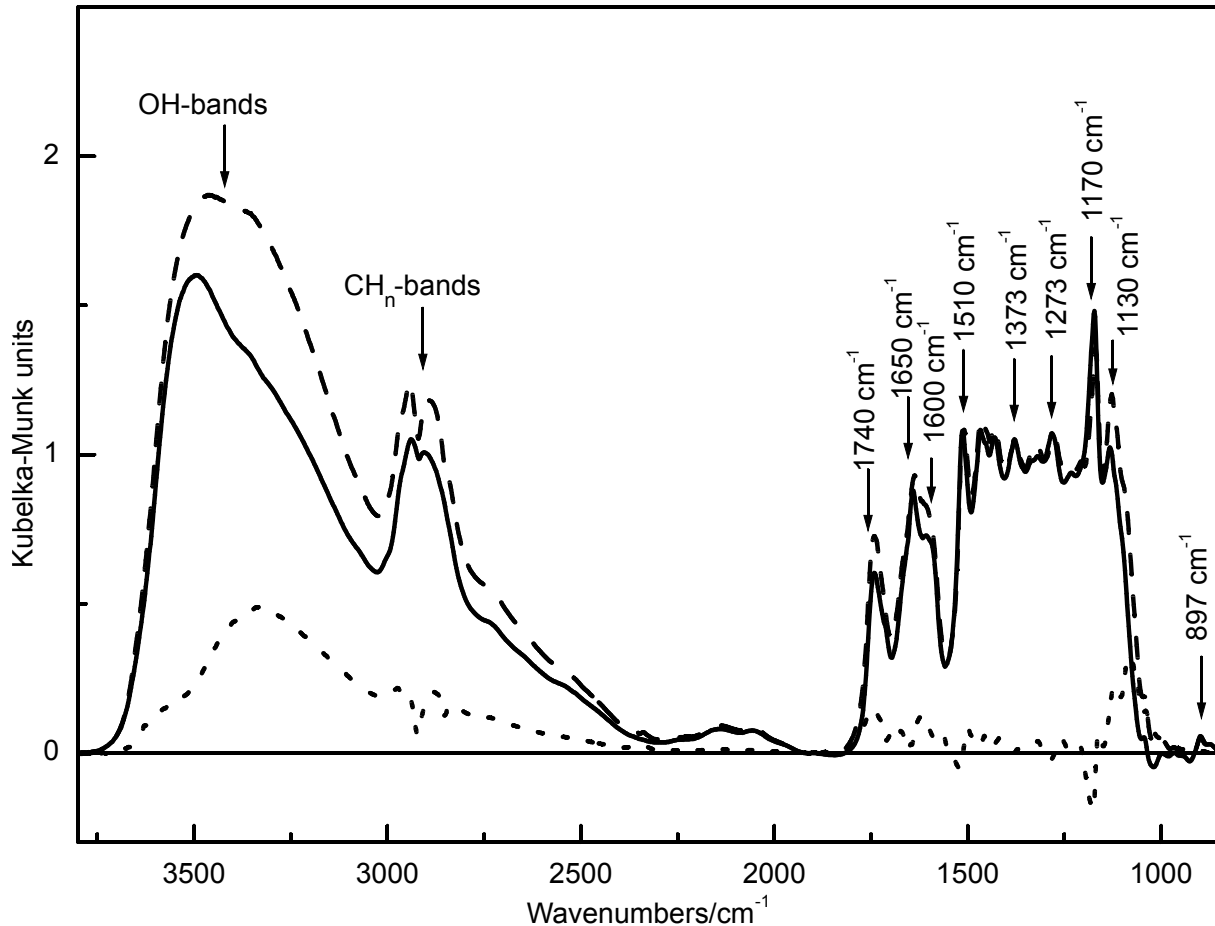

Figure 2. DRIFT spectra of larch between 3800 cm^{-1} and 850 cm^{-1} (earlywood of heartwood) without treatment (solid), irradiated with 160 J (dashed) and their difference (dotted)

3.1 Changes in the spectra between 3800 and 1800 cm^{-1} (Figure 3)

In the OH-band region ($3700\text{--}3050\text{ cm}^{-1}$) absorption may increase or decrease, depending on the energy. At low energy levels, the left side of the band and even the centre of the band decrease. In the case of 40 and 80 J this decrease is much more pronounced, than the nondescript increase in the absorption on the right side of the band. Around the maxima and the right side of the band the absorption increases with the rise of energy. In this range, the difference spectra are always positive for 120 and 160 J. At the same time the definite decrease at the left side of the band is followed by increase, and for 160 J the difference spectra became positive for all of the samples.

Investigation results indicate that there are several processes in the OH-band region during irradiation. At low energies, processes that cause decrease in absorption at the left side range of band are dominant. This is very likely due to the decomposition of H bridge bonds, which do not need large amount of energy. Concurrently, hydroxyl groups start to appear, but this process is slower. One of the reasons is that the surface of the specimen becomes rougher and rougher due to the high energy density laser impulses reaching the samples within a short time period, so it is capable to adsorb more and more moisture from the surrounding air. This adsorbed moisture content appears as an increase in the OH band region. In the CH_n range ($3000\text{--}2900\text{ cm}^{-1}$) absorption always increases in softwood, regardless of energy.

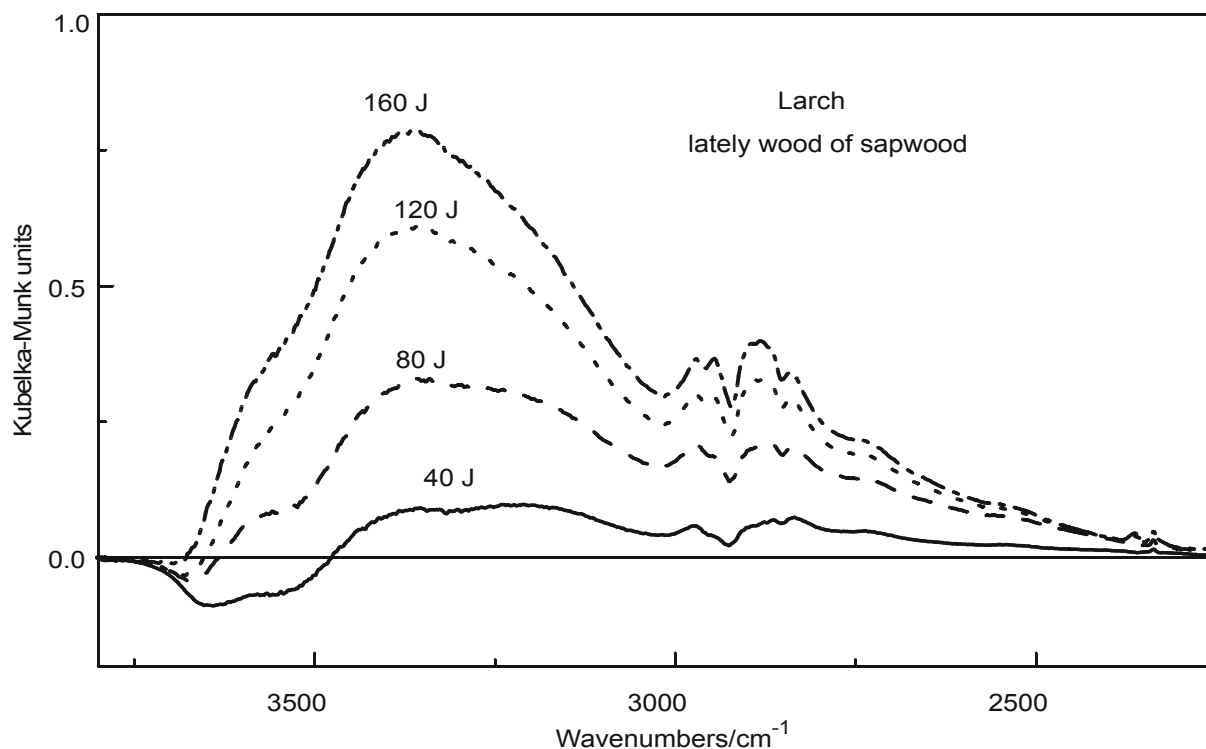
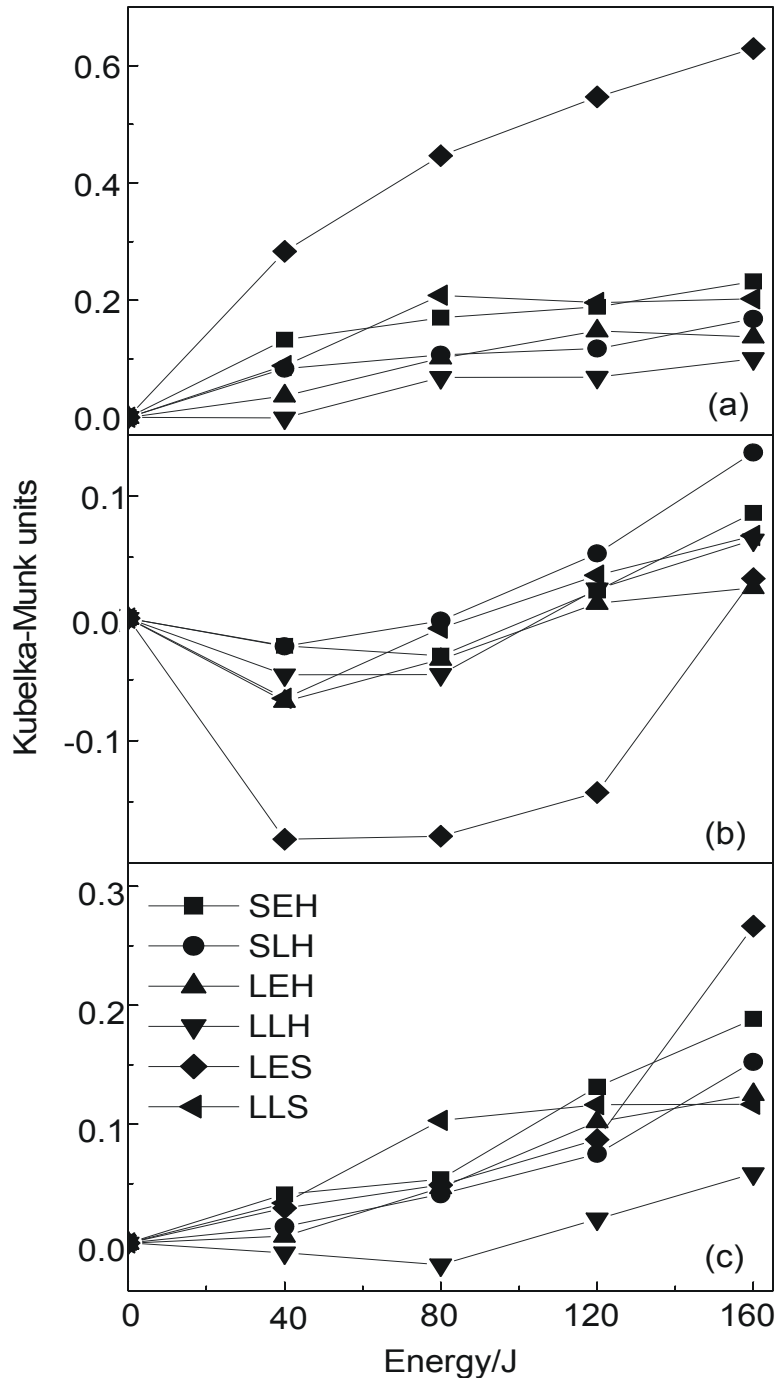

Figure 3. Difference spectra of larch (latewood of sapwood) between 3800 cm^{-1} and 2250 cm^{-1} irradiated with different impulse numbers from UV lasers

3.2 Changes in the spectra between 1850 and 850 cm^{-1}

The absorption region between 1800 and 1550 cm^{-1} behaved differently after irradiating the samples with different energies. In the band of non-conjugated carbonyl groups (1780 - 1700 cm^{-1}) a broad absorption increase can be observed around 1740 cm^{-1} , as a result of irradiating the samples with KrF laser at both energy levels (Figure 4(a)) in agreement with earlier results (Papp et al. 2001). A decrease in absorbance around 1650 cm^{-1} (conjugated carbonyl groups and adsorbed water in wood capillaries) can be observed in the spectra for low irradiation energy, which is followed by increase for at high energy levels (Figure 4(b)). The difference spectra became positive after irradiating the sample with 160 J . The decrease can be attributed to loss of water as well as of conjugated C=O groups. But at higher energies the number of conjugated carbonyl groups increases, and this rise exceeds the rate of decrease. In the range of 1620 - 1560 cm^{-1} (syringyl units and carboxyl ions of lignin), our observations contradict the literature dealing with time-dependent processes of change in absorption (Hon – Feist 1986). In softwood, the intensity is growing, which is slower at low energies and more pronounced at high energy levels (Figure 4(c)). Since the syringyl content of lignin in softwood is low, the increase of carboxyl ions at low energy exceeds the decomposition of rings, and this is the reason why there is no decrease in absorption even at 40 J . The only sign of the decomposition of syringyl units is the slower increase in intensity. The characteristic absorption band of aromatic rings around 1510 cm^{-1} decreases even at 40 J , but this decrease is slower at higher energies (Figure 5(a)). The bands between 1460 cm^{-1} and 1315 cm^{-1} are practically unchanged during fractional treatment. The band around 1273 cm^{-1} , belonging to the guaiacyl units of lignin decreases (Figure 5(b)), in agreement with the literature (Hon – Chang 1984; Hon 1994). The absorption continuously decreases around 1234 cm^{-1} in the earlywood of larch sapwood, while there is no change in the other

samples. The intensity of absorption around 1170 cm^{-1} , belonging to cellulose and hemicellulose C-O-C groups decreases constantly (Figure 5(c)), but the rate of decrease is slower at higher energies. The absorption at 1130 cm^{-1} , 1090 cm^{-1} and 1045 cm^{-1} increases for all of the samples. There is no change at 897 cm^{-1} , which band belongs to C1-H bond of the pyranose ring of cellulose.



Legend: first letters: S – Scots pine, L – Larch
 second letters: E – Earlywood, L – Latewood
 third letters: H – Heartwood, S – Sapwood

Figure 4. Difference spectra of softwood as a function of energy for the bands at 1740 cm^{-1} (a), at 1650 cm^{-1} (b) and at 1600 cm^{-1} (c)

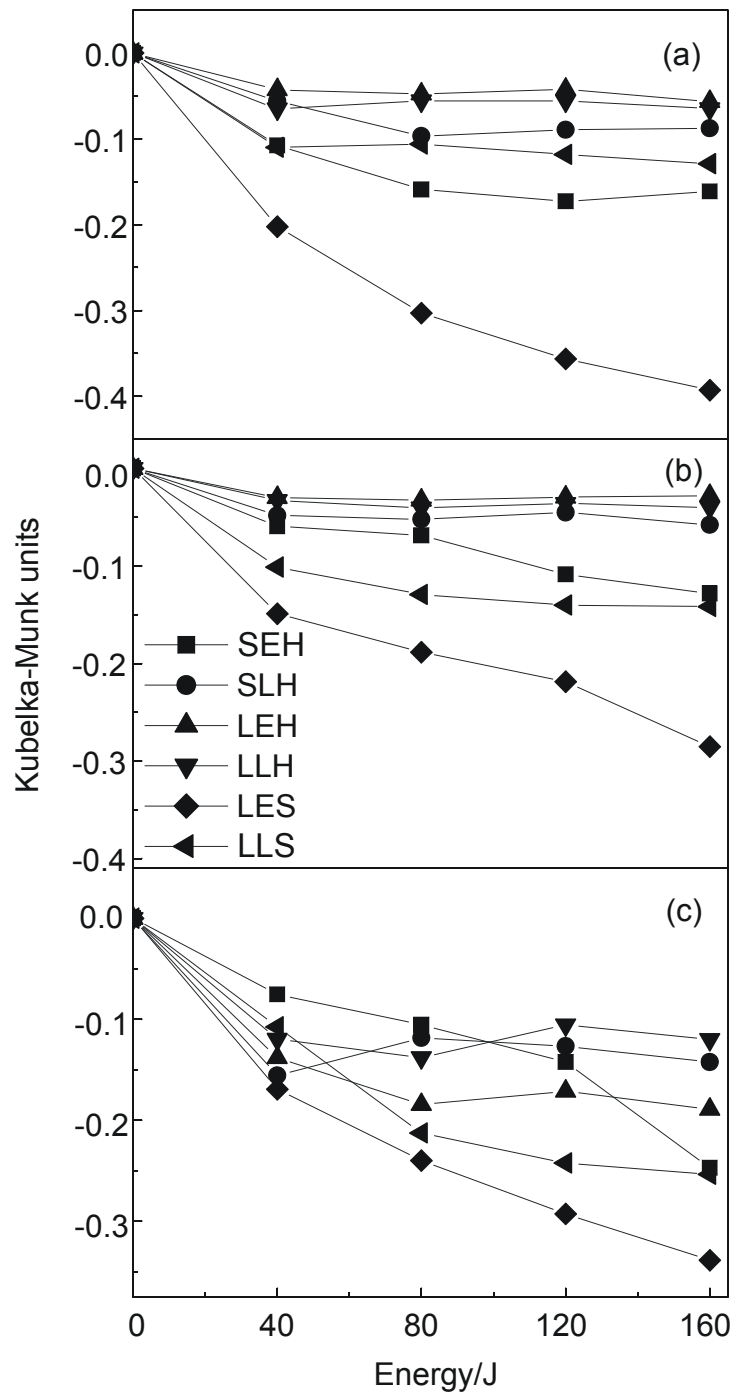

Legend: first letters: S – Scots pine, L – Larch
 second letters: E – Earlywood, L – Latewood
 third letters: H – Heartwood, S – Sapwood

Figure 5. Difference spectra of softwood as a function of energy for the bands at 1510 cm^{-1} (a), at 1273 cm^{-1} (b) and at 1170 cm^{-1} (c)

4 CONCLUSIONS

Broad absorption bands that belong to the same chemical groups located at various positions of wood constituents (i.e. OH-groups around 3700-3050 cm^{-1} , CH_n -groups around 2930-2895 cm^{-1} , non conjugated carbonyl groups around 1780-1700 cm^{-1}) show no consistent change of absorption at different energy doses. The intensity of OH bands in the treated samples can be higher or lower depending on the amount of radiation energy. Furthermore, within the wide band the rate of increase and decrease is different at different wave number ranges. In the CH_n region and in the band of non-conjugated carbonyl groups only absorption increase can be observed for softwood. Bands resulting from only one chemical component (1510 cm^{-1} : aromatic rings, 1273 cm^{-1} : guaiacyl units, 1170 cm^{-1} : C–O–C bonds in the cellulose), and containing no other absorption maxima around them, uniformly decreased. This decrease was continuous but damped down with absorbed energy, and after a certain amount of energy it can also come to a stop. The regions where the band of a chemical component lies next to another one (for example 1650 cm^{-1} : conjugated carbonyl groups and adsorbed water in wood capillaries, 1620-1560 cm^{-1} : syringyl units and carboxylates in lignin, besides 1460, 1425, 1130 cm^{-1} bands), no uniform changes were observed during the irradiation. The initial decrease was followed by increase.

Acknowledgements: Part of this work was supported by the Hungarian Ministry of Education under the contract FKFP 0419/1999.

REFERENCES

- BACKA, S. – BROLIN A. (1991): Determination of pulp characteristics by diffuse reflectance FTIR. *Tappi Journal* 5: 218-226.
- BARTA, E. – TOLVAJ, L. – PAPP, G. – NAGY, T. – SZATMÁRI, S. – BERKESI, O. (1998): Wood degradation caused by UV-laser 248 nm wavelength. *Holz als Roh-und Werkstoff* 56: 318.
- BARTA, E. – TOLVAJ, L. – NAGY, T. – SZATMÁRI, S. – BERKESI, O. – PAPP, G. (1999): Photodegradation of leaf-woods caused by 248.5 nm laser. *Wood Research (Drevársky Vyskum)* 44: 13-19.
- DIRCKX, O.G. – MASSON, D.M. – DEGLISE, X.M. (1987): Photodegradation du bois, de la cellulose et de la lignine. *Wood and Pulping Chemistry Symposium Paris*
- HESS, C. L. (1952): An investigation of the homogeneity of isolated native black spruce lignin. *Tappi Journal* 35: 315-319
- HON, D.N-S. – CHANG, S-T. (1984): Surface degradation of wood by ultraviolet light. *Journal of Polymer Science* 22: 2227-2241
- HON, D.N-S. – Feist, W.C. (1986): Weathering characteristics of hardwood surfaces. *Wood Sciences and Technology* 20: 169-183.
- HON, D.N-S. (1994): Degradative effects of ultraviolet light on wood surface quality. *Wood and Fiber Science* 26: 185-191.
- KALININS, M. A. (1966): Surface characteristics of wood as they affect durability of finishes. Part II. Photochemical degradation of wood. U.S. Forest Service Research Paper 57: 23-61
- KOŠÍKOVÁ B. – TOLVAJ, L. (1998): Structural changes of lignin-polysaccharide complex during photodegradation of *Populus grandis*. *Wood Research (Drevársky Vyskum)* 43: 37-46
- KUBELKA, P. (1948): New contributions to the optics of intensely light-scattering materials. Part I, *JOSA*, 38: 448-451.
- KUBELKA, P. (1954): New contributions to the optics of intensely light-scattering materials Part II: Nonhomogeneous Layers, *JOSA*, 44: 330-335.
- MARTON, J. – SPARKS, H.E. (1967): Determination of lignin in pulp and paper by infrared multiple internal reflectances. *Tappi Journal* 50: 363-367.

- MICHELL A.J. (1988a): Second derivative FTIR spectra of woods. Tenth Cellulose Conference, Syracuse
- MICHELL, A.J. (1988b): Note on a technique for obtaining infrared spectra of treated wood surfaces. *Wood and Fiber Science* 20: 272-276.
- OWEN, N.L. – THOMAS, D.W. (1989): Infrared studies of „hard” and „soft” woods. *Applied Spectroscopy* 43: 451-455.
- PANDEY K.K. – THEAGARAJAN K.S. (1997): Analysis of wood surfaces and ground wood by diffuse reflectance (DRIFT) and photoacoustic Fourier transform infrared spectroscopic techniques. *Holz als Roh- und Werkstoff* 55: 383-390.
- PAPP, G., – TOLVAJ, L. – BARTHA, E. (1999): Changes in DRIFT Spectra of silver maple and lignin extracted from the same wood caused by 248.5 nm laser. 4th International Conference on the Development of Wood Science, Wood Technology and Forestry, High Wycombe, England, 14-16 July 1999, 494-501.
- PAPP, G. – BARTA, E. – TOLVAJ, L. – NAGY, T. – SZATMÁRI, S. – BERKESI, O. (2001): Wood degradation caused by KrF UV laser. *Technology Letters* 5: 1-8.
- PAPP, G. – PREKLET, E. – KOŠÍKOVÁ, B. – BARTA, E. – TOLVAJ, L. – BOHUS, J. – SZATMÁRI, S. – BERKESI, O. (2004): Effect of UV laser radiation with different wavelengths on the spectrum of lignin extracted from hard wood materials, *Journal of Photochemistry & Photobiology, A: Chemistry* 163: 187-192.
- SCHULTZ, T.P. – GLASSER W.G. (1986): Quantitative structural analysis of lignin by diffuse reflectance fourier transform infrared spectrometry. *Holzforschung* 40: 37-44.
- TYLLI, H. – FORSSKAHL, I. – OLKONNEN, C. (1993): A spectroscopic study of photoirradiated cellulose. *J. Photochem. Photobiol. A: Chemistry* 76: 143-149.
- ZAVARIN, E.S. – JONES, S.J. – COOL, L.G. (1990): Analysis of solid wood surfaces by diffuse reflectance infrared Fourier Transform (DRIFT) spectroscopy. *Journal of Wood Chemistry and Technology* 10: 495-513.

Technische Festigkeiten der Pannonia Pappel (*Populus x euramericana* cv. Pannonia) und der Zerreiche (*Quercus cerris* L.)

József SZALAI*

Institut für Technische Mechanik und Tragwerke, Westungarische Universität, Sopron, Ungarn

Zusammenfassung – Im Institut für Technische Mechanik und Tragwerke der Westungarischen Universität wurde – durch die Unterstützung von OTKA (T 34107) (Ungarischer Förderungsfonds der Wissenschaftlichen Forschung) – seit mehreren Jahren eine theoretische und experimentelle Untersuchung durchgeführt. Im Rahmen dieser Untersuchung werden die Grundlagen der statischen Bemessung von Holzkonstruktionselementen ausgearbeitet und jene Materialkonstanten für verschiedene Holzarten experimentell ermittelt, welche für eine theoretisch einwandfreie statische Bemessung benötigt werden.

Bei der Bemessung von lasttragenden Holzkonstruktionen – besonders dann, wenn im geprüften Punkt ein zusammengesetzter Spannungszustand herrscht – braucht man eine anisotrope Festigkeitshypothese. Diese Festigkeitskriterien sind mathematisch gesehen Polynome, in deren Gleichungen die Koeffizienten materialabhängige Größen sind. In diesem Artikel werden die Komponenten des Festigkeitstensors und die sogenannten technischen Festigkeiten für die Pannonia Pappel und Zerreiche zusammengefasst. Es handelt sich dabei um Laubhölzer, die bei Neuaufforstungen im Rahmen der Umstrukturierung der ungarischen Land- und Forstwirtschaft bevorzugt zur Anpflanzung gelangen sollen.

Festigkeits-theorie / Festigkeitsoberfläche / technische Festigkeiten / statische Bemessung / Pannonia Pappel / Zerreiche

Kivonat – A pannónia nyár (*Populus x euramericana* cv. Pannonia) és a csertölgy (*Quercus cerris* L.) **technikai szilárdságai**. Teherviselő faszerkezetek méretezésekor – különösen, ha a vizsgált elem kritikus pontjaiban összetett feszültségi állapot uralkodik – az anizotrop anyagok valamelyik tönkremeneteli elméletét kell alkalmazni. Ezek a tönkremeneteli kritériumon matematikai szempontból polinomok, melyekben az együtthatók anyagjellemzők, illetve azok függvénye. E cikkben a Pannónia nyár és a csertölgy faanyag technikai szilárdságait és az ezek alapján számított szilárdsági tenzor-komponenseket mutatjuk be.

tönkremeneteli elmélet / technikai szilárdságok / erőtani méretezés / Pannónia nyár / csertölgy

* jkszalai@fmk.nyme.hu; H-9401 SOPRON, Pf. 132

1 EINLEITUNG

Für die Beschreibung der Festigkeit von anisotropen Stoffen gibt es mehrere Hypothesen, deren Vor- und Nachteile in der Arbeit von J. Szalai (1995) ausführlich diskutiert wurden. Auf Grund der theoretischen und experimentellen Untersuchungen erwies sich für das Holz als am geeignetsten die Theorie von E.K. Ashkenasi (1966, 1978). Über die Theorie und Verwendung dieser Festigkeitshypothese, über die Methode der Bemessung auf Grund der zugelassenen Spannungen und der Grenzspannungen wurde auf den Seiten nachstehender Zeitschriften unlängst zusammenfassend berichtet (J. Szalai 1990, 1994, 1995, 1996, 1997).

Die Verwendung des Ashkenasi'schen Festigkeitskriteriums ist nur dann möglich, wenn die technischen Festigkeiten der einzelnen Holzarten bekannt sind. Und zwar bekannt auf einem von der Praxis annehmbaren Sicherheitsniveau. Theoretisch benötigt man 27 verschiedene technische Festigkeiten, deren experimentelle Ermittlung teuer und meistens kompliziert ist. Die Festigkeitshypothese ist aber auch dann mit für die Praxis ausreichender Genauigkeit zu verwenden, wenn ein Minimalsystem der technischen Festigkeiten bekannt ist. Diese sind die Zug- und Druckfestigkeiten in den anatomischen Hauptrichtungen und in den Richtungen der Winkelhalbierenden der anatomischen Hauptachsen:

$$\left. \begin{aligned} & f_L^+, f_L^-, f_R^+, f_R^-, f_T^+, f_T^-, \\ & f_{LR}^{T(45)+}, f_{LR}^{T(45)-}, f_{LT}^{R(45)+}, f_{LT}^{R(45)-}, f_{RT}^{L(45)+}, f_{RT}^{L(45)-} \end{aligned} \right\}, \tag{1}$$

wobei

- L – die Längs- bzw. die Faserrichtung,
- R – die radiale Richtung,
- T – die tangentielle Richtung bedeuten.

In Kenntnis der 12 Normalfestigkeiten sind die zu den Hauptebenen gehörenden Scherfestigkeiten auf Grund der Ashkenasi'schen Festigkeitstheorie rechnerisch zu bestimmen (E.K. Ashkenasi 1978, J. Szalai 1992, 1994). Somit stehen 15 Materialkennzeichen zur Verfügung. Die mit diesen technischen Festigkeiten berechneten Komponenten des Ashkenasi'schen Festigkeitstensors können in einer Matrix T_{ij} gefasst werden, wie die Formel (2) zeigt. Diese Matrixenelemente beschreiben das Festigkeitsverhalten am genauesten, wenn $\sigma^{LL} \geq 0, \sigma^{RR} \geq 0$ und $\sigma^{TT} \geq 0$ sind. Die Tensorkomponenten sollen immer mit der Verwendung jener technischen Festigkeiten berechnet werden, welche dem Vorzeichen der Normalspannungen des tatsächlichen Spannungszustandes entsprechen (im Falle der Scherfestigkeiten müssen die Vorzeichen nicht in Betracht gezogen werden):

$$T_{ij} = \begin{array}{|c|c|c|c|c|c|} \hline & \frac{1}{f_L^*} & \frac{1}{2} \left(\frac{4}{f_{LR}^{T(45)+}} \frac{1}{f_L^+} \frac{1}{f_R^+} \frac{1}{t_{RL}} \right) & \frac{1}{2} \left(\frac{4}{f_{LT}^{R(45)+}} \frac{1}{f_L^+} \frac{1}{f_T^+} \frac{1}{t_{TL}} \right) & 0 & 0 & 0 \\ \hline \frac{1}{2} \left(\frac{4}{f_{LR}^{T(45)+}} \frac{1}{f_L^+} \frac{1}{f_R^+} \frac{1}{t_{RL}} \right) & & \frac{1}{f_R^+} & \frac{1}{2} \left(\frac{4}{f_{RT}^{L(45)+}} \frac{1}{f_R^+} \frac{1}{f_T^+} \frac{1}{t_{RT}} \right) & 0 & 0 & 0 \\ \hline \frac{1}{2} \left(\frac{4}{f_{LT}^{R(45)+}} \frac{1}{f_L^+} \frac{1}{f_T^+} \frac{1}{t_{TL}} \right) & \frac{1}{2} \left(\frac{4}{f_{RT}^{L(45)+}} \frac{1}{f_R^+} \frac{1}{f_T^+} \frac{1}{t_{RT}} \right) & & \frac{1}{f_T^+} & 0 & 0 & 0 \\ \hline & 0 & 0 & 0 & \frac{1}{t_{RT}} & 0 & 0 \\ \hline & 0 & 0 & 0 & 0 & \frac{1}{t_{TL}} & 0 \\ \hline & 0 & 0 & 0 & 0 & 0 & \frac{1}{t_{LR}} \\ \hline \end{array} \tag{2}$$

2 TECHNISCHE FESTIGKEITEN UND FESTIGKEITSTENSOREN

Im *Bild 1* werden die realen Probenkörper verschiedener Orientierung der Pannonia Pappel und ihre charakteristischen Bruchbilder gezeigt.



Bild 1. Probenkörper aus Pannonia Pappel bei sechs verschiedenen Orientierungen für Zug- und Druckbeanspruchung und ihre charakteristischen Bruchbilder

Die Ergebnisse der experimentellen Untersuchungen für die Pannonia Pappel und Zerreiche wurden in der *Tabelle 1 und 2* zusammengefasst. Für die statistische Auswertung wurden die Arbeiten von W. Weibull (1939), T.A. Kontorova – J.L. Frenkel (1941), J. Korda, (1972) und E. Mistéth (1974, 1977) verwendet. *Tabelle 3* zeigt die Charakteristika der zu den anatomischen Hauptebenen gehörenden Scherfestigkeiten. Diese Scherfestigkeiten wurden durch eine indirekte Methode mit den statistischen Werten der Normalfestigkeiten berechnet. Dieses Verfahren ermöglicht auch die Bestimmung der statistischen Charakteristika der Scherfestigkeiten.

Tabelle 1. Statistische Charakteristiken der Zug- und Druckfestigkeiten der Pannonia Pappel

Dichte im Darrzustand: 0,34 g/ccm

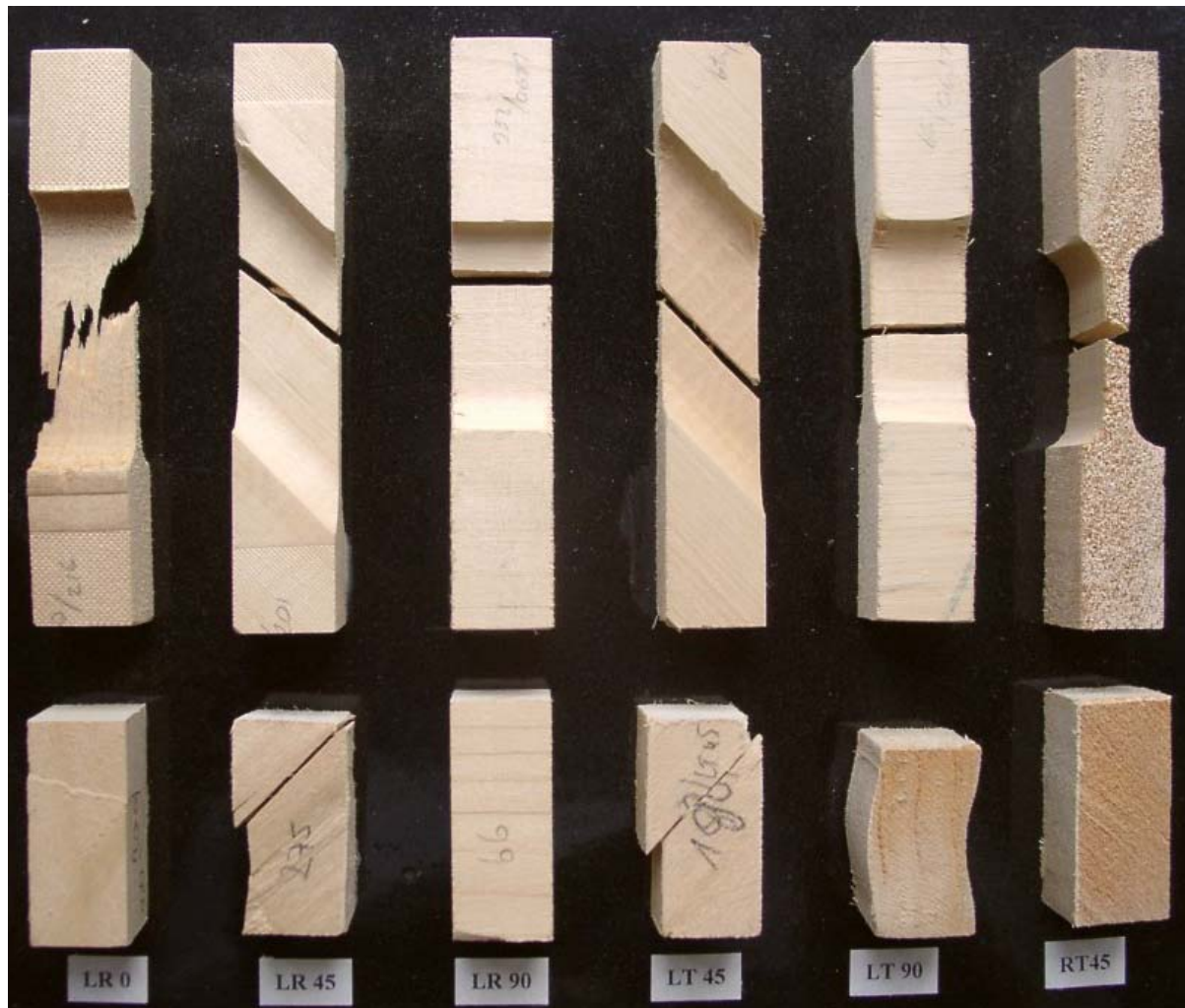
Feuchtigkeitsgehalt: 12%

	Beanspruchung: Zug						
	LR0	LR45	LR90	LT45	LT90	RT45	
Umfang der Probe	300	300	300	296	300	300	Stück
Mittelwert	82,24	7,86	6,32	8,76	4,18	4,78	MPa
Standardabweichung	18,69	1,67	1,00	1,39	0,42	0,54	MPa
Varianz	0,23	0,21	0,16	0,16	0,10	0,11	%
Schiefe	1,00	1,38	-0,17	0,92	1,09	0,02	-
Kurtosis	1,29	0,87	0,52	0,73	0,22	0,28	-
Art der Verteilung	Pearson III.	Pearson III.	Pearson III.	lognormal	Weibull	Pearson III.	-
Niveau der Signifikanz	2,22	9,04	91,85	76,42	0,51	58,52	%
Normativwert (5%)	57,63	5,63	4,74	5,57	3,48	3,95	MPa
Untere Grenze ($\gamma=0,99$)	53,91	5,30	4,66	5,12	3,45	3,90	MPa
Obere Grenze ($\gamma=0,99$)	61,36	5,96	4,82	6,01	3,50	4,01	MPa
Grenzwert (0,1%):	48,89	4,78	3,54	5,57	3,00	3,40	MPa
Untere Grenze ($\gamma=0,99$)	43,03	4,25	3,32	5,12	2,92	3,27	MPa
Obere Grenze ($\gamma=0,99$)	54,75	5,32	3,76	6,01	3,08	3,53	MPa
	Beanspruchung: Druck						
	LR0	LR45	LR90	LT45	LT90	RT45	
Umfang der Probe	300	300	300	300	300	297	Stück
Mittelwert	34,45	8,72	4,37	6,32	3,04	3	MPa
Standardabweichung	2,69	1,2	0,65	1	0,31	0,38	MPa
Varianz	7,82	13,72	14,75	15,82	10,22	12,57	%
Schiefe	-0,87	-0,40	0,63	0,22	0,70	1,11	-
Kurtosis	1,31	0,67	-0,13	-0,17	2,98	2,31	-
Art der Verteilung	Weibull	normal	Weibull	Pearson III.	lognormal	Weibull	-
Niveau der Signifikanz	0,002	0,12	51,72	61,66	0,001	0,77	%
Normativwert (5%):	29,48	6,75	3,45	4,74	2,59	2,54	MPa
Untere Grenze ($\gamma=0,99$)	29,23	6,51	3,37	4,66	2,53	2,45	MPa
Obere Grenze ($\gamma=0,99$)	29,72	7,00	3,53	4,83	2,66	2,62	MPa
Grenzwert (0,1%)	22,61	5,02	3,18	3,54	2,34	2,46	MPa
Untere Grenze ($\gamma=0,99$)	22,48	4,64	3,06	3,32	2,21	2,36	MPa
Obere Grenze ($\gamma=0,99$)	22,75	5,41	3,30	3,76	2,47	2,57	MPa

Tabelle 2. Statistische Charakteristiken der Zug- und Druckfestigkeiten der Zerreiche

Dichte im Darrzustand: 0,76 g/ccm

Feuchtigkeitsgehalt: 12%

	Beanspruchung: Zug						
	LR0	LR45	LR90	LT45	LT90	RT45	
Umfang der Probe	300	300	226	300	300	286	Stück
Mittelwert	72,24	20,65	13,72	21,94	9,85	10,93	MPa
Standardabweichung	10,72	3,05	1,59	4,27	1,4	1,56	MPa
Varianz	0,15	0,15	0,14	0,2	0,14	0,14	%
Schiefe	-1,41	-0,54	-0,25	-0,63	-0,21	-1,41	-
Kurtosis	5,48	0,53	0,37	0,35	-0,41	3,64	-
Art der Verteilung	Weibull	Weibull	Weibull	Weibull	normal	Weibull	-
Niveau der Signifikanz	24,30	28,00	9,15	37,94	0,940	0,03	%
Normativwert (5%):	52,24	15,15	10,43	14,17	7,44	8,03	MPa
Untere Grenze ($\gamma=0,99$)	48,74	15,10	10,37	14,03	7,39	7,58	MPa
Obere Grenze ($\gamma=0,99$)	55,73	15,20	10,50	14,31	7,48	8,47	MPa
Grenzwert (0,1%)	19,38	9,25	7,73	5,21	5,53	3,25	MPa
Untere Grenze ($\gamma=0,99$)	4,96	9,02	7,42	5,02	5,36	2,48	MPa
Obere Grenze ($\gamma=0,99$)	25,37	9,48	8,04	5,41	5,70	4,02	MPa
	Beanspruchung: Druck						
	LR0	LR45	LR90	LT45	LT90	RT45	
Umfang der Probe	300	298	300	216	300	300	Stück
Mittelwert	51,97	22,92	14,67	21,36	10,02	10,94	MPa
Standardabweichung	6,82	3,26	1,75	3,11	0,95	1,21	MPa
Varianz	13,13	14,23	11,90	14,55	9,43	11,03	%
Schiefe	0,47	-0,42	-0,34	0,89	-1,21	-0,11	-
Kurtosis	-0,26	1,04	0,49	1,63	2,31	0,22	-
Art der Verteilung	Pearson III.	normal	Weibull	Pearson III.	Weibull	Weibull	-
Niveau der Signifikanz	9,67	0,00	23,71	50,3	0,006	8,06	%
Normativwert (5%)	41,73	17,55	11,60	17,15	8,26	8,89	MPa
Untere Grenze ($\gamma=0,99$)	41,00	16,88	11,57	16,41	8,07	8,83	MPa
Obere Grenze ($\gamma=0,99$)	42,45	18,23	11,63	17,88	8,44	8,95	MPa
Grenzwert (0,1%)	35,36	12,85	8,85	15,43	5,36	7,43	MPa
Untere Grenze ($\gamma=0,99$)	33,76	11,79	8,63	14,21	5,09	7,24	MPa
Obere Grenze ($\gamma=0,99$)	36,88	13,90	9,07	16,65	5,63	7,62	MPa

Tabelle 3. Charakteristiken der zu den anatomischen Hauptebenen gehörenden Scherfestigkeiten der Pannonia Pappel und der Zerreiche

<i>Scherfestigkeit</i>		Pannonia Pappel			Zerreiche		
		LR Ebene	LT Ebene	RT Ebene	LR Ebene	LT Ebene	RT Ebene
Mittelwert	MPa	9,32	8,50	2,02	20,58	16,85	5,82
Standardabweichung	MPa	4,01	2,16	0,58	5,07	2,66	1,15
Varianz	%	42,99	25,39	28,78	24,64	15,82	19,76
Schiefe	-	0,28	0,06	0,04	0,12	0,46	0,24
Kurtosis	-	-	-	-	-	-	-
Art der Verteilung	-	Pearson III.	Pearson III.	Pearson III.	Pearson III.	Pearson III.	Pearson III.
Niveau der Signifikanz	%	-	-	-	-	-	-
Normativwert (5%)	MPa	3,06	4,67	0,95	12,42	12,84	4,01
Untere Grenze ($\gamma=0,99$)	MPa	2,67	4,49	0,90	12,03	12,51	3,91
Obere Grenze ($\gamma=0,99$)	MPa	3,45	4,85	1,00	12,81	13,17	4,12
Grenzwert (0,1%)	MPa	-1,51	1,73	0,15	5,77	10,33	2,66
Untere Grenze ($\gamma=0,99$)	MPa	-2,47	1,25	0,02	4,67	9,62	2,39
Obere Grenze ($\gamma=0,99$)	MPa	-0,55	2,20	0,28	6,87	11,03	2,93
<i>Pearson III. Verteilung</i>							
x0	MPa	-19,78	-62,76	-24,93	-64,37	5,35	-3,60
lambda(p)	-	1,81	15,28	79,51	3,30	1,62	7,12
r(p)	-	52,71	1089,16	2143,16	280,51	18,61	67,10
Mittelwert	MPa	9,32	8,51	2,02	20,58	16,85	5,83
Standardabweichung	MPa	4,01	2,16	0,58	5,07	2,67	1,15
Varianz	-	0,43	0,25	0,29	0,25	0,16	0,20
Schiefe	-	0,28	0,06	0,04	0,12	0,46	0,24
Kurtosis	-	0,11	0,01	0,00	0,02	0,32	0,09
<i>Weibull Verteilung</i>							
x0	MPa	-0,718	1,92	0,22	5,98	11,11	2,87
lambda(p)	-	0,09	0,14	0,50	0,06	0,15	0,30
r(p)	-	2,70	3,36	3,43	3,16	2,28	2,78
Mittelwert	MPa	9,32	8,51	2,02	20,58	16,85	5,83
Standardabweichung	MPa	4,01	2,16	0,58	5,07	2,67	1,15
Varianz	-	0,43	0,25	0,29	0,25	0,16	0,20
Schiefe	-	0,28	0,06	0,04	0,12	0,46	0,25
Kurtosis	-	-0,21	-0,29	-0,29	-0,28	-0,02	-0,23

Die in den Tabellen befindlichen Daten (Mittelwert, Standardabweichung, Varianz, Schiefe, Kurtosis) entsprechen den wohlbekanntesten statistischen Parametern. Die unteren und oberen Grenzen der 5% und 0,1% Fraktile bedeuten, dass die Normativwerte und die Grenzwerte mit einer Wahrscheinlichkeit von 99% (Konfidenzzahl $\gamma = 0,99$) in dieses Intervall fallen.

Auf Grund der Tabelle 1 und 2 können die Matrizen verschiedener Wahrscheinlichkeitsniveaus wie folgt zusammengestellt werden.

Der Ashkenasi'sche Festigkeitstensor der Pannonia Pappel

- mit der Verwendung der Mittelwerte, wenn alle Normalspannungen des wirkenden Spannungszustandes positiv sind:

$$T_{ij(\text{Mittelwert})} = \begin{bmatrix} 0,01216 & 0,10230 & 0,04034 & 0 & 0 & 0 \\ 0,10230 & 0,15820 & -0,03223 & 0 & 0 & 0 \\ 0,04034 & -0,03223 & 0,23915 & 0 & 0 & 0 \\ 0 & 0 & 0 & 0,50429 & 0 & 0 \\ 0 & 0 & 0 & 0 & 0,12444 & 0 \\ 0 & 0 & 0 & 0 & 0 & 0,13386 \end{bmatrix}, [1/\text{MPa}] \quad (3)$$

- mit der Verwendung der Mittelwerte, wenn alle Normalspannungen des wirkenden Spannungszustandes negativ sind:

$$T_{ij(\text{Mittelwert})} = \begin{bmatrix} 0,02903 & 0,03350 & 0,07525 & 0 & 0 & 0 \\ 0,03350 & 0,06944 & 0,13563 & 0 & 0 & 0 \\ 0,07525 & 0,13563 & 0,32895 & 0 & 0 & 0 \\ 0 & 0 & 0 & 0,50429 & 0 & 0 \\ 0 & 0 & 0 & 0 & 0,12444 & 0 \\ 0 & 0 & 0 & 0 & 0 & 0,13386 \end{bmatrix} \cdot [1/\text{MPa}] \quad (4)$$

Der Ashkenasi'sche Festigkeitstensor der Zerreiche

- mit der Verwendung der Mittelwerte, wenn alle Normalspannungen des wirkenden Spannungszustandes positiv sind:

$$T_{ij(\text{Mittelwert})} = \begin{bmatrix} 0,01384 & 0,01773 & 0,00208 & 0 & 0 & 0 \\ 0,01773 & 0,07289 & -0,00449 & 0 & 0 & 0 \\ 0,00208 & -0,00449 & 0,28818 & 0 & 0 & 0 \\ 0 & 0 & 0 & 0,20054 & 0 & 0 \\ 0 & 0 & 0 & 0 & 0,06274 & 0 \\ 0 & 0 & 0 & 0 & 0 & 0,07152 \end{bmatrix}, [1/\text{MPa}] \quad (5)$$

- mit der Verwendung der Mittelwerte, wenn alle Normalspannungen des wirkenden Spannungszustandes negativ sind:

$$T_{ij(\text{Mittelwert})} = \begin{bmatrix} 0,01924 & 0,00780 & 0,00272 & 0 & 0 & 0 \\ 0,00780 & 0,06817 & -0,00144 & 0 & 0 & 0 \\ 0,00272 & -0,00144 & 0,09980 & 0 & 0 & 0 \\ 0 & 0 & 0 & 0,20054 & 0 & 0 \\ 0 & 0 & 0 & 0 & 0,06279 & 0 \\ 0 & 0 & 0 & 0 & 0 & 0,07152 \end{bmatrix} \cdot [1/\text{MPa}] \quad (6)$$

Verwendet man für die Berechnung die normativen Werte oder die 0,1 % Fraktilwerte, so ergeben sich die Komponenten des zugelassenen Spannungstensors bzw. des Grenzspannungstensors.

In den *Bildern 2 bis 7* wurden die Festigkeitsoberflächen der Mittelwerte für jene Fälle dargestellt, wenn im Koordinatensystem der anatomischen Hauptrichtungen ein ebener Spannungszustand herrscht. Diese Oberflächen können ebenso auch mit den zusammengehörenden Fraktilwerten dargestellt werden. So spricht man über eine zugelassene Spannungsoberfläche oder eine Grenzspannungsoberfläche usw. Mit Hilfe der Festigkeitsoberflächen kann das Prinzip der Bemessung effektiv veranschaulicht werden. Liegt der Spannungspunkt im gewählten Koordinatensystem unterhalb der Festigkeitsoberfläche, so erfolgt kein Versagen des Materials im untersuchten Punkt.



Bild 2. Festigkeitsoberfläche der Pannonia Pappel in der Hauptebene L-R



Bild 3. Festigkeitsoberfläche der Pannonia Pappel in der Hauptebene L-T

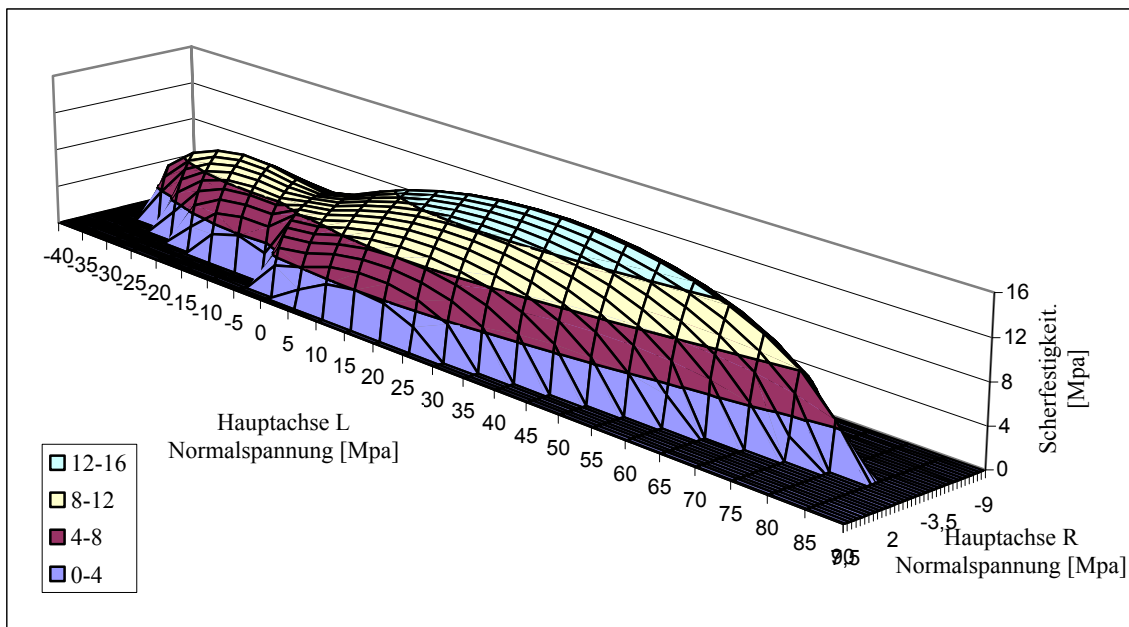

Bild 4. Festigkeitsoberfläche der Pannonia Pappel in der Hauptebene R-T

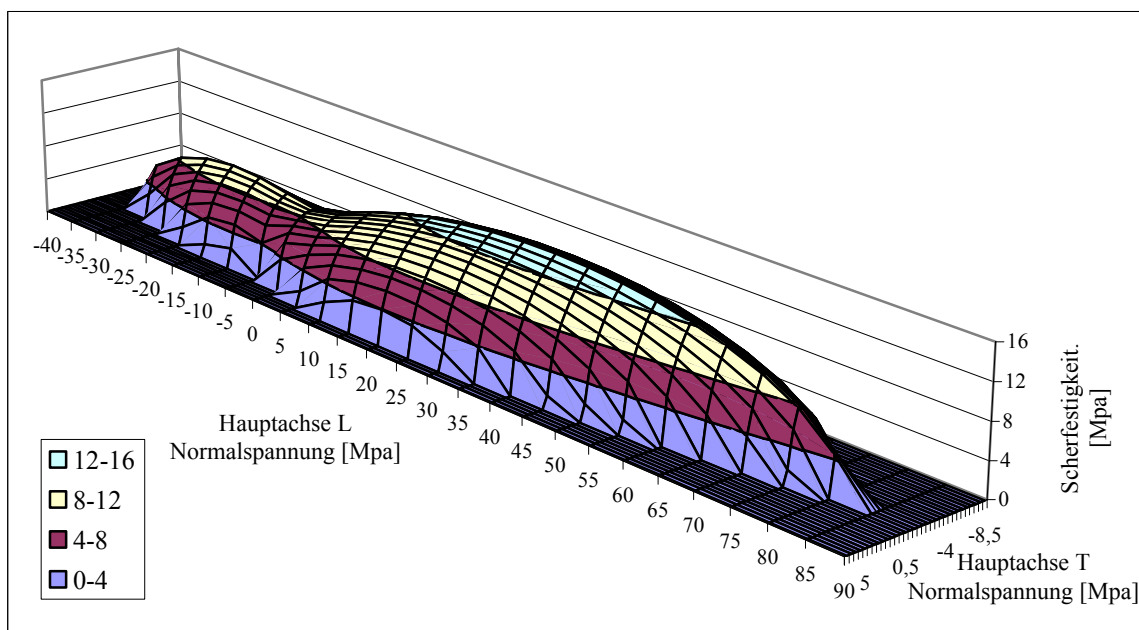

Bild 5. Festigkeitsoberfläche der Zerreiche in der Hauptebene L-R

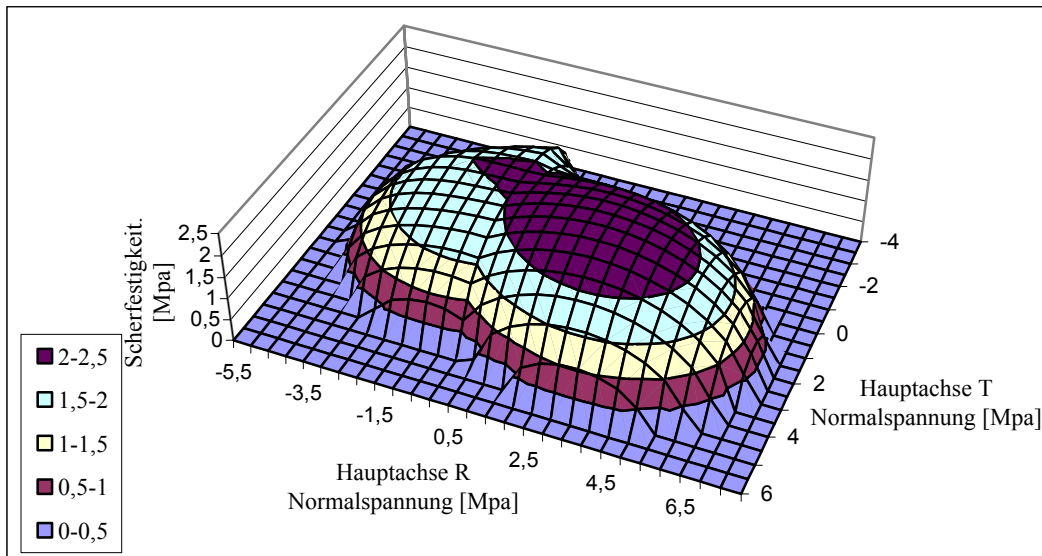

Bild 6. Festigkeitsoberfläche der Zerreiche in der Hauptebene L-T

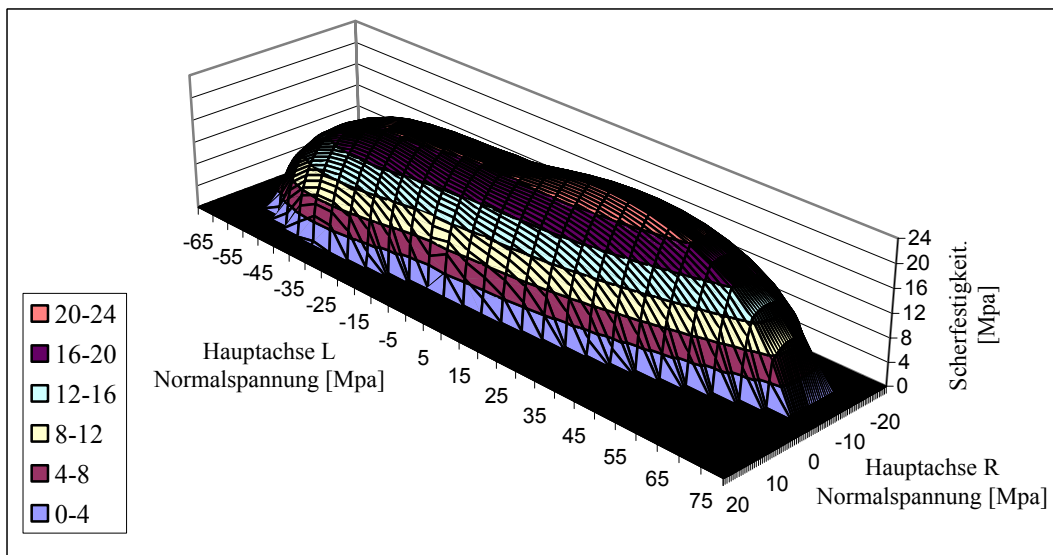

Bild 7. Festigkeitsoberfläche der Zerreiche in der Hauptebene R-T

3 SCHLUSSBEMERKUNGEN

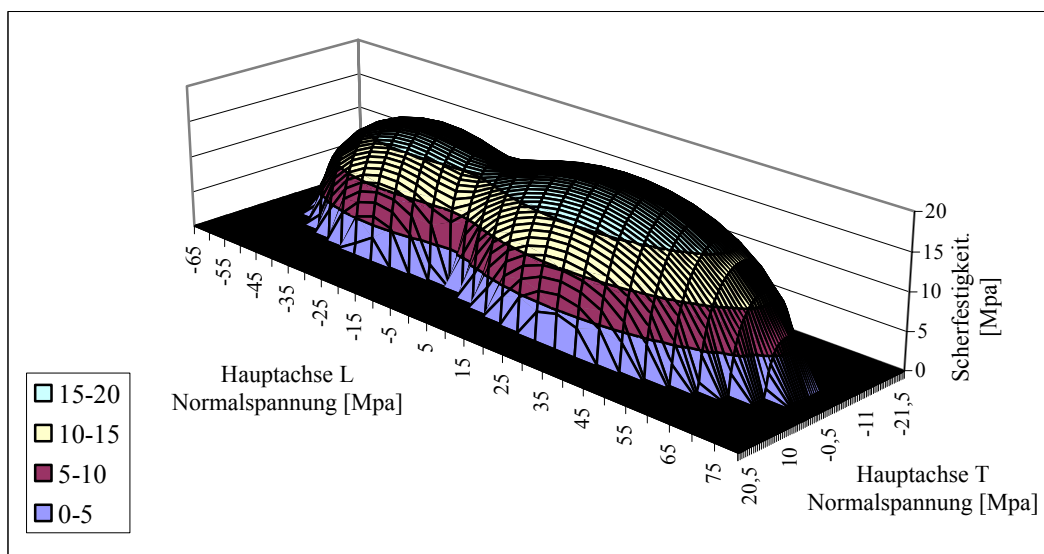
Auf Grund der Tabellen 1, 2 und 3 können wir feststellen, dass die Anzahl der Elemente einer Stichprobe um 300 Stück gerade noch annehmbar ist. Das wird von dem Signifikanzniveau bewiesen, welche für die Anpassung der Verteilungsfunktionen bestimmt wurde. Die kleineren Signifikanzwerte weisen auf ein grundsätzliches Problem hin. Die Vielfältigkeit, die natürliche Streuung der physikalisch-mechanischen Eigenschaften einer Holzart ermöglicht es nicht, dass nur eine begrenzte Stichprobe untersucht wird. Bei größerer Anzahl der Proben braucht man aber mehrere Stämme (selbst für 300 Probenkörper reicht ein einziger Stamm meistens nicht aus und es treten sogar innerhalb eines Stammes größere Abweichungen auf), was wiederum eine größere Streuung verursacht.

Laut J. Korda (1972) und E. Mistéth (1974, 1977) hat die Verteilungsfunktion von zähen (plastischen) Stoffen eine positive, laut W. Weibull (1939) und T.A Kontorova – J.I. Frenkel (1941) jene von spröden Stoffen eine negative Schiefe.

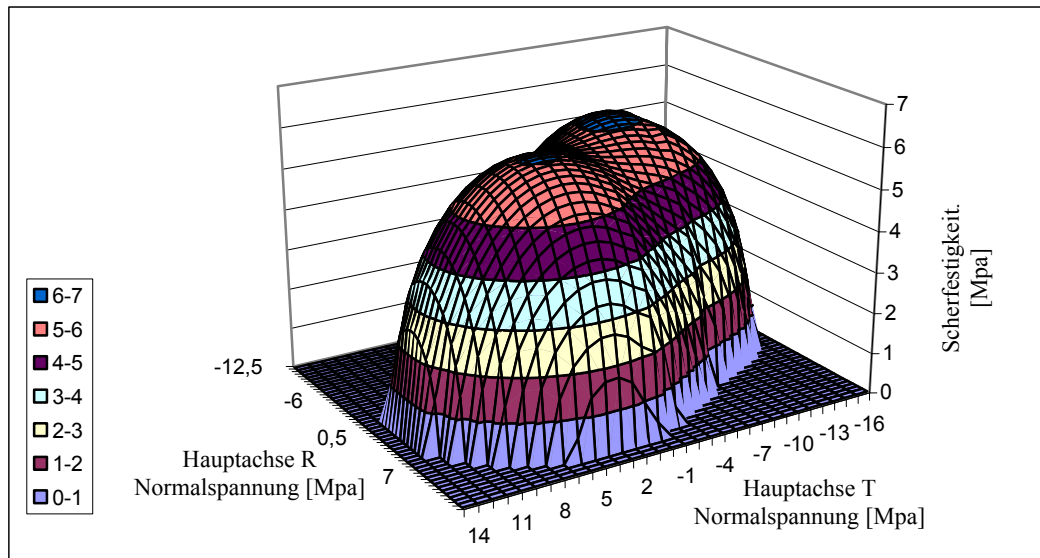
Von 12 Stichproben folgen bei der Pannonia Pappel vier der Weibull Verteilung, sie haben also eine negative Schiefe. Die übrigen haben eine Normal-, Lognormal-, oder hauptsächlich Pearson III. Verteilung. Auf Grund der Verteilungen kann nicht eindeutig darauf geschlossen werden, dass sich die Pannonia Pappel als ein spröder Stoff verhält. Erfahrungsgemäß ist aber die Art des Bruches auch bei der Pannonia Pappel spröde. Der Widerspruch weist darauf hin, dass die Zahl der Elemente der Stichprobe immer noch zu klein ist.

Von 12 Stichproben bei der Zerreiche folgen acht der Weibull Verteilung, sie haben eine negative Schiefe. Nur eine Probe weist eine positive Schiefe auf (zwei sind normalverteilt. Dieses Verhältnis entspricht besser unserer Vorstellung und Erfahrung, dass nämlich die Zerreiche bei jeder Beanspruchung einen spröden Bruch aufweist.

Danksagung: Die Arbeit wurde durch den Ungarischen Förderungsfonds der Wissenschaftlichen Forschung (OTKA T 34107) gefördert, wofür an dieser Stelle gedankt sei.

LITERATUR

- ASHKENASI, E.K. (1966): Festigkeit von Holz und synthetischen Werkstoffen (auf Russisch). Lesnaja Promyslennost', Moskau. 165 S.
- ASHKENASI, E.K. (1978): Anisotropie von Holz und Holzwerkstoffen (auf Russisch). Lesnaja Promyslennost'. Moskau. 220 S.
- KONTOROVA, T.A. – FRENKEL, J.I. (1941): Statistische Theorie der spröden Festigkeit von realen Kristallen (auf Russisch). Zurnal Techn. Fiz. T11. No. 3.
- KORDA, J. (1972): Viszkoplasztikus anyagok húzó- és nyomószilárdságának valószínűségelméleti megítélése. Mélyépítéstudományi Szemle. 1972/4.
- MISTÉTH, E. (1974): Erőtani méretezés valószínűségelméleti alapon. ÉMI kiadványsorozata, 23. szám. ÉTK 1974. 195 S.
- MISTÉTH, E. (1977): Többcélú létesítmények gazdaságos méretezésének alapelvei a valószínűségelmélet alkalmazásával. Doktori értekezés. Budapest. 214 S.
- SZALAI, J. (1990): A természetes faanyag anizotrop szilárdsági kritériumainak összehasonlítása alkalmazhatóságuk szempontjából. Építés-, Építészettudomány. XXI/1-4.: 23-57.
- SZALAI, J. (1992): Indirekte Bestimmung der Scherfestigkeiten des Holzes mit Hilfe der anisotropen Festigkeitstheorie. Holz als Roh- und Werkstoff 50: 233-238.
- SZALAI, J. (1994): A természetes faanyag és faalapú anyagok szilárdsági viselkedésének jellemzői, tönkremeneteli feltételének megfogalmazása. Közlekedésépítés- és Mélyépítéstudományi Szemle. XLIV/4: 123-130.
- SZALAI, J. (1994): A természetes faanyag és faalapú anyagok nyírószilárdságának anizotróp szilárdsági kritériumon alapuló közvetett meghatározása. Közlekedésépítés- és Mélyépítéstudományi Szemle. XLIV/7: 275-283.
- SZALAI, J. (1994): A faanyag és faalapú anyagok erőtani méretezése összetett feszültségi állapot esetén. Építés-, Építészettudomány. XXIV/3-4. 215-223.
- SZALAI, J. (1995): A faanyag és faalapú anyagok anizotrop rugalmasság- és szilárdságtana. I. rész: A mechanikai tulajdonságok anizotrópiája. Hillebrand Nyomda Kft. Sopron. 398 S.
- SZALAI, J. (1996): Az erdei fenyő (*Pinus silvestris*) technikai szilárdságai. Bútor & Faipar. II/6-7: 14-15.
- SZALAI, J. (1996): Teherviselésre alkalmas (hazai) fafajok faanyagának szilárdsági tenzorában szereplő komponenseinek számításához szükséges technikai szilárdságok kísérleti meghatározása. OTKA (T 4434) Zárójelentés. Kutatási időszak: 1992-1996. Sopron. 261 S.
- SZALAI, J. (1997): Technische Festigkeiten des Buchenholzes (*Fagus silvatica*). Drevársky Vyskum. 42(3): 1-13.
- WEIBULL, W. (1939): A Statistical theory of the strength of materials. Proc. Roy. Swedish Inst. Eng. Ros. Stockholm. No. 2. 151 S.

Relation Between Static and Dynamic Modulus of Elasticity of Wood

Ferenc DIVÓS^{a*} – Toshinari TANAKA^b

^a Institute of Wood and Paper Technology, University of West Hungary, Sopron, Hungary

^b Forestry and Forest Products Research Institute, Tsukuba, Japan

Abstract – Static and dynamic modulus of elasticity (MOE) of spruce lumber were determined under different conditions like cross head speed, bending and longitudinal vibration, and mode numbers. The characteristic time of MOE determination is introduced. Characteristic time is defined as the typical MOE determination time. Shorter characteristic times are shown to result in higher MOE values. An order of magnitude change in characteristic time resulted in a 1.7% change in MOE. We found clear evidence that creep exists on a short time scale.

modulus of elasticity / static and dynamic determination / creep wood

Kivonat – Kapcsolat a faanyag statikus és dinamikus rugalmassági modulusza között. Lucfenyő fűrészárú rugalmassági moduluszának meghatározását a mérési körülmények befolyásolják, úgy mint a az anyagvizsgáló gép sebessége, dinamikus mérés esetén a hajlító és longitudinális rezgések, illetve az alkalmazott módusok száma. A rugalmassági modulusz meghatározásának jellemzésére a karakterisztikus időt vezettük be, mely a mérésre fordított időt jelenti. A rövidebb karakterisztikus idő magasabb rugalmassági moduluszt eredményez. Egy nagyságrend változás a karakterisztikus időben, 1,7% változást jelent a rugalmassági modulusz meghatározásában. Ez egyértelmű bizonyítéka a kúszás jelenségének rövid időtartományokon.

rugalmassági modulusz / statikus és dinamikus meghatározás / kúszás / faanyag

1 INTRODUCTION

Since 1960, much attention has been paid to the non-destructive evaluation of wood, especially with regard to mechanical grading. A large number of papers deal with the determination of the modulus of elasticity in bending (MOE) and its correlation with modulus of rupture in bending (MOR). The result of this research demonstrates that the most important strength predictor parameter is MOE. This predictor has been determined by static and dynamic methods. Because the different methods of determination give a dynamic value that is about 10% higher than the static value, the two values of MOE have been handled as different parameters. Static and dynamic MOE determination were compared by several authors (Perstorper 1994; Tanaka *et al.* 1991; Kliger *et al.* 1992, Jugo and Ozarska 1996) who found

* Corresponding author: divos@fmk.nyme.hu; H-9400 SOPRON, Pf. 132

good correlation (r^2 : 0.90 – 0.96) between the two MOE values. In this study we demonstrate that the difference between dynamic and static MOE values can be explained by the effect of creep.

The deflection of a beam under load is composed of the sum of elastic deflection and deflection caused by creep. In practice, the effect of creep is not often taken into consideration. In the standard methods for the determination of MOE, there are regulations for controlling strain rate in the tests. In the case of dynamic MOE determination, the effect of creep is usually not taken into consideration.

2 METHOD OF MOE DETERMINATION

Evaluating the effect of creep on MOE determination requires the measurement of MOE as precisely as possible. We need to take into account the effects of shear and other influencing factors and to eliminate the effects of temperature and moisture changes. The air temperature and humidity of the laboratory was controlled (20°C and 70% respectively). Testing started after 4 months of conditioning, so specimen temperature was 20°C and moisture content was 13.3±0.4%. To eliminate the effect of defects we used clear spruce specimens, that is, specimens without knots, slope of grain and other imperfections. All specimens were taken from one large spruce beam. The typical specimen size was 5.5 by 11.0 by 130 cm. In the study we utilised the following methods for determining MOE: stress waves, dynamic bending and static bending. These 3 methods cover a wide range in characteristic time (to be defined later) from 1 ms to 600 s.

When a stress wave of velocity V is induced in a bar of density ρ and length L then

$$MOE_{str} = \rho V^2 = \rho (2L f_{long})^2 \quad (1)$$

MOE_{str} is the modulus of elasticity determined by this method. Velocity of stress wave is often determined by the frequency (f_{long}) of longitudinal vibration. In the stress wave MOE calculation, a correction

$$f = f_0 \left(1 + \frac{n^2 \pi^2 \mu^2 (a^2 + b^2)}{24L^2} \right) \quad (2)$$

was used (Rayleigh 1945) where f is the limiting frequency for a very long beam, f_0 is the observed frequency, μ is the Poisson's ratio, a and b are the dimensions of the bar, n is the mode number.

Bending vibration provides a rather quick and precise method for determining MOE. In this method the beam is supported at the nodal points by soft material. In *Figure 1*, two vibration modes and associated nodal points are shown. Timoshenko's beam theory (Timoshenko and Young 1954) and Hearmon's correction (Hearmon 1966) were used in the evaluation of MOE. Since MOE is included in Hearmon's formula, an iterative process is necessary to determine the correction factor.

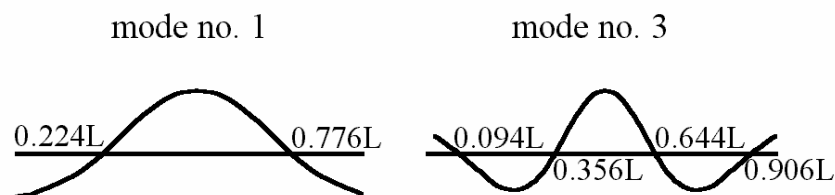

Figure 1. Locations of nodal points in free bending vibration of bar

for the first and third vibration mode

A testing machine was used to measure the static modulus of elasticity (MOE_{stat}). In the case of 3 point loading, the following formula accounts for the effect of shear:

$$MOE_{stat} = \frac{Fl^3}{48I\Delta S - 3Flb^2 / 2G} \quad (3)$$

where: F : the applied force
 ΔS : deflection (within the elastic range)
 l : span
 b : depth of specimen
 G : shear modulus
 I : $ab^3/12$ (a is the width of the specimen)

The shear modulus (G) of the specimen was determined by torsional vibration, based on the method described by Hearmon (Hearmon 1966).

It is not easy to compare the three modulus of elasticity determinations. The stress distributions in the beam are different for the different methods and, due to the heterogeneity of wood, the determined MOE values are also different. However, with the use of defect free specimens, it is possible to keep the effect of different stress distributions in the different methods to a minimum. Another main difference is the characteristic time of determination. With this approach, the effect of time causing creep can be evaluated. We strongly believe that creep exists not only over a long time scale, but also over a short duration.

We need to determine the characteristic time of the measurement. The characteristic time of stress wave MOE determination is the time of one period of longitudinal vibration: $T=1/f$. This is true for beams shorter than 2.5 m. However, for longer beams, the longitudinal stress waves separate (see *Figure 2*). In this case, the characteristic time cannot be determined by $1/f$ because it becomes constant at about 1 ms.

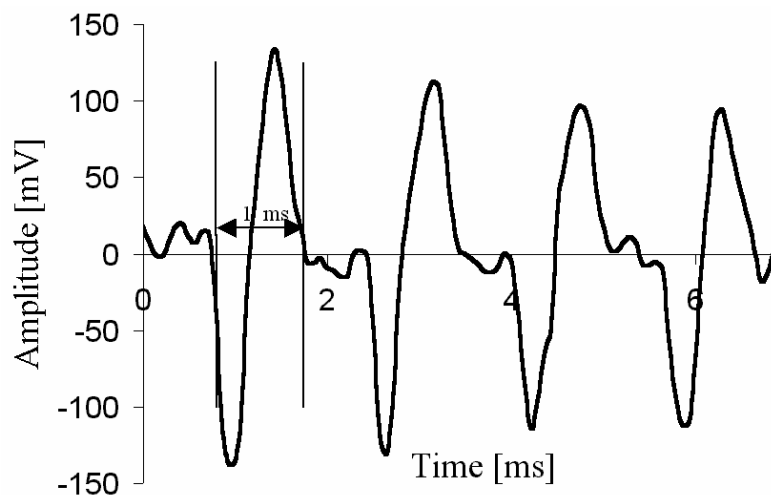

Figure 2. Separation of longitudinal stress waves in a 427 cm long 2 by 4 specimen.

The characteristic time for dynamic bending MOE determination is simply the time of one period of longitudinal vibration regardless of the specimen dimensions.

The time for static MOE measurement varies according to the maximum deflection attained during the test. The standard methods for small clear specimens specify the rate of strain or the rate of crosshead movement. For example ASTM D143-83 specifies 2.5 mm/min. for crosshead speed. In case of construction size timber the crosshead speed depends on the

dimensions of the specimen. For the timber specimens we used, the time it took to reach the 4 MPa stress level was taken as the characteristic time. This method of determination of characteristic time is arbitrary. The 4 MPa stress level was chosen because with this characteristic time we got the best fit between static and dynamic measurements. This characteristic time represents the time needed for 1 mm deflection at 1 m span in 3 point loading.

3 RESULTS AND DISCUSSION

We have defined a creep parameter (η'), in order to analyse the effect of creep on MOE determination as:

$$\eta' = \frac{MOE_t - MOE_0}{MOE_0} 100 \quad (4)$$

where: MOE_0 : reference modulus of elasticity,

MOE_t : the MOE at t characteristic time.

Figure 3a shows the measured MOE for 21 clear spruce specimens as a function of characteristic time. Static MOE at 0.1, 1, 10 and 100 mm/min crosshead speed (600, 60, 6 and 0.6 sec characteristic time respectively), dynamic bending MOE at a mode number 1 and 3, and stress wave MOE were determined. The time scale is logarithmic. The tendency is that a higher MOE is obtained with shorter characteristic time. Using these data we calculated the creep parameter η' using formula (4) where the MOE measured at 10 mm/min. crosshead speed was chosen as the reference: MOE_0 . Figure 3b shows the creep parameter (η') as a function of characteristic time.

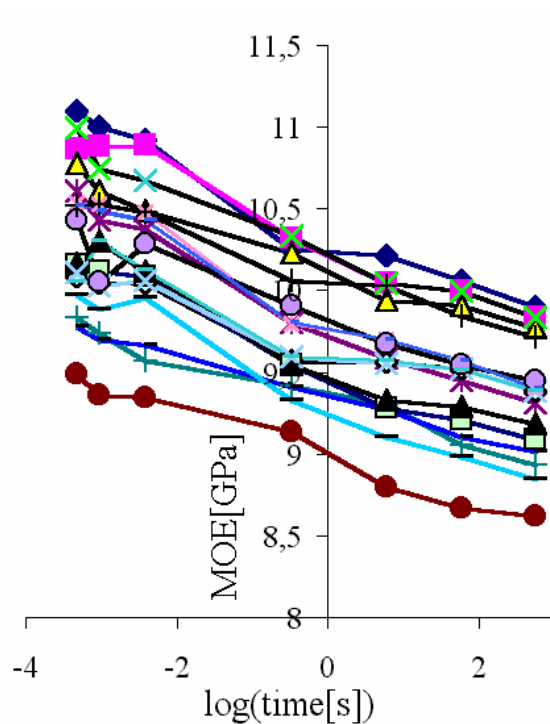

Figure 3a.

Measured stress wave, dynamic bending and static MOE as a function of characteristic time

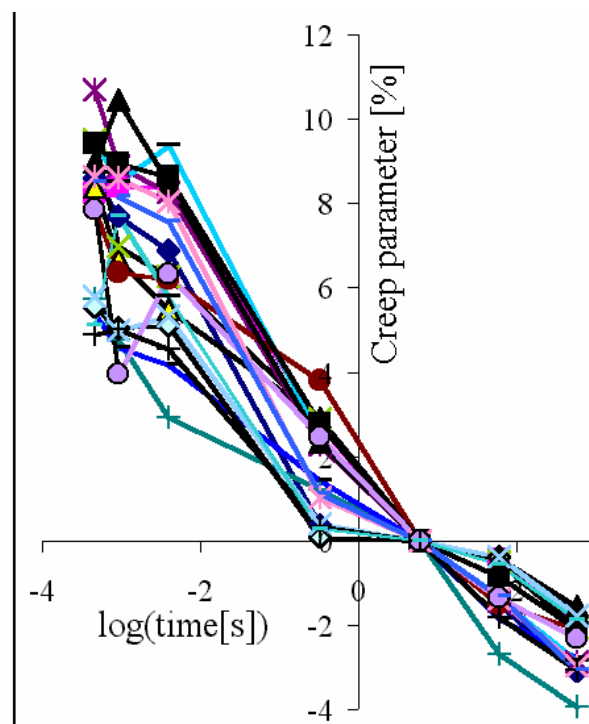

Figure 3b.

Creep parameter, η' , as a function of characteristic time

To define the most likely relationship we used the average MOE of 21 specimens. This averaging reduced the scatter caused by the heterogeneity of wood and measurement error. The average MOE values are plotted in *Figure 4*.

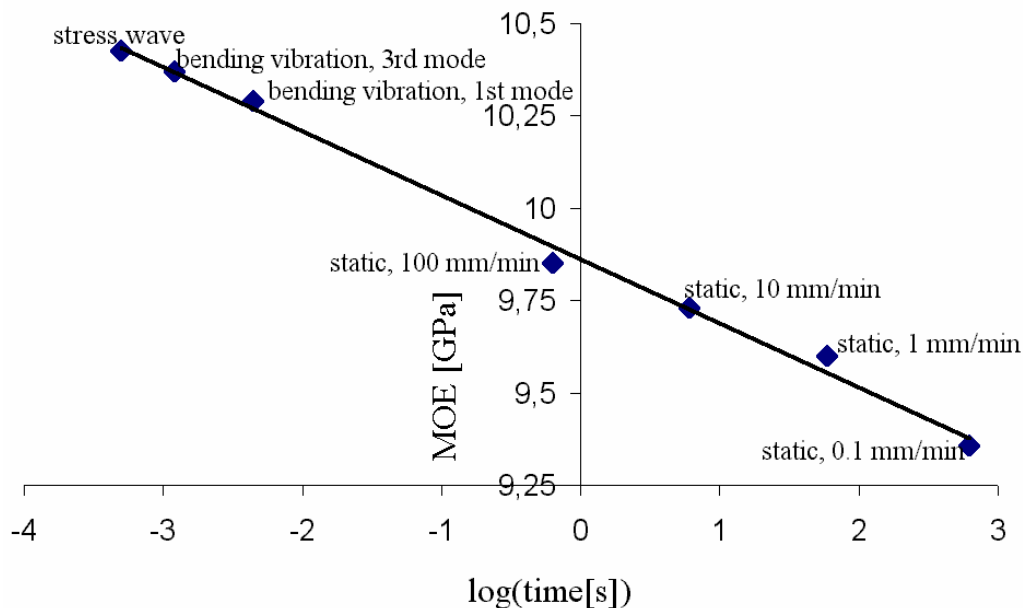

Figure 4. Average MOE as a function of characteristic time.

The averaged points were fitted with a straight line. Practical use of this result is a formula that calculates the effect of the characteristic time:

$$MOE_{t_1} = MOE_{t_2} (1 + 0.017 \log(t_2 / t_1)) \quad (5)$$

where: t_1 : the characteristic time of MOE_{t_1} determination

t_2 : the characteristic time of MOE_{t_2} determination

For example, using the formula (5), it is possible to predict the static MOE using dynamic MOE data. In this case, t_1 equals 25 seconds, which is the characteristic time of the standard static MOE determination for a small clear specimen.

The effect of creep appears in a paper by Nakao (Nakao *et al.* 1995) where MOE of wood is plotted as a function of resonance order. At higher resonance order (shorter characteristic time) the author observed higher MOE. The line shown in *Figure 4* also demonstrates the effect of creep in short time scales. One order of magnitude change in characteristic time results 1.7% change in MOE. The effect of creep on dynamic modulus of elasticity determination is important, not only for wood, but also for other materials where creep is not negligible, such as plastics.

Acknowledgments: Thanks are extended to R. Bruce Anderson, Assistant Professor of Wood Science, West Virginia University, Morgantown, West Virginia, USA, who edited the text of this paper. This work was supported by the Science and Technology Agency, Japan via an STA fellowship.

REFERENCES

- HEARRMON R.F.S., (1966): Vibration testing of wood. *Forest Products Journal* 16 (8): 29-40.
- JUGO, I. – OZARSKA, B. (1996): Nondestructive evaluation of properties of reconstituted wood products used in Australia. 10th 8th International Symposium on Nondestructive Testing of Wood. Swiss Federal Institute of Technology, Lausanne, Switzerland.
- KLIGER, R. – PERSTORPER, M., JOHANSSON G. (1992): Stiffness in structural timber - effect according to position in the stem. Proc. IUFRO S5.02 Timber Engineering Meeting, Laboratoire de Rheologie du Bois de Bordeaux, Bordeaux, France.
- NAKAO T. et al. (1995): Experimental study of flexural vibration of wooden beams by Levison beam theory. *Journal of Vibration and Acoustics* 117: 378-379.
- PERSTORPER, M. (1994): Strength and stiffness prediction of timber using conventional and dynamic methods. Proc. First European Symposium on Nondestructive evaluation of Wood, University of Sopron, Sopron, Hungary.
- RAYLEIGH, L. (1945): *Theory of Sound*. Vol. 1, 2nd edition, Macmillan, New York.
- TANAKA, T. – NAGAO, H. – NAKAI, T. (1991): Nondestructive evaluation of bending and tensile strength by longitudinal and transverse vibration of lumber. Proc. 8th International Symposium on Nondestructive Testing of Wood, Conferences and Institutes, Washington State University, Pullman, USA.
- TIMOSHENKO S. – YOUNG D.H. (1954): *Vibration problems in engineering*. 3rd edition, Van Nostrand, New York.

Development of Cement Bonded Composite Beams

László BEJÓ* – Péter TAKÁTS – Norbert VASS

Institute of Wood and Paper Technology, University of West Hungary, Sopron, Hungary

Abstract – The paper reports on the early steps in the development of cement bonded composite beams. The advantage of such products is that they are lighter than reinforced concrete, while more fire-resistant than solid wood or traditional composite beams. Experimental beams were produced to imitate the structure of organic bonded PSL and LSL, using poplar veneer strips and Scots pine strands. In this phase of the research, the aim was to verify that such products are feasible, compare different beam types, and determine the focus for the ongoing development of cement-bonded composite beams.

The manufactured beams were found to be fairly lightweight, but their mechanical properties were lower than those of solid wood or composite beams. PSL type beams performed better than cement-bonded LSL. Problem areas that caused the relatively poor performance were identified. Further experimental work will be directed at improving the mechanical performance of the beams.

cement bonded wood composites / composite beams / non-destructive testing

Kivonat – A cement-kötésű kompozit gerendák kifejlesztésének kezdeti lépései. Ezen újságcikk a cementkötésű kompozit gerendák kifejlesztésére tett első kísérleteket mutatja be. E termékek előnye, hogy könnyebbek a vasbetonnál, azonban tűzállóbbak a tömörfánál és a hagyományos kompozit gerendáknál. A szerves kötésű PSL és LSL termékekhez hasonló szerkezetű kísérleti gerendák nyár furnércsíkokból, illetve erdei fenyő strand-ekből készültek. A kutatás jelenlegi szakaszának a célja az ilyen termékek kivitelezhetőségének ellenőrzése, a különböző gerendafajták összehasonlítása és a cementkötésű kompozit gerendák további fejlesztési irányának meghatározása volt.

Az elkészült termékek önsúlya viszonylag alacsony volt, azonban mechanikai tulajdonságai elmaradtak a tömörfától vagy más kompozit gerendaféleségektől. A PSL jellegű tartók nagyobb szilárdságúak lettek az LSL típusúaknál. A kutatás következő szakaszának célja az új termék mechanikai tulajdonságainak javítása bizonyos gyártástechnológiai problémák megoldása által.

cementkötésű fakompozitok / kompozit gerendák / roncsolásmentes vizsgálatok

1 INTRODUCTION

Recent years brought a renewed interest in wood-based construction in many European countries. Despite the manifold advantages, structural application of natural wood and wood based composites represent certain challenges. The biggest problem is the typical and not always groundless classification of wood as a flammable material (Wood Handbook 1999).

* Corresponding author: lbejo@fmk.nyme.hu; H-9401 SOPRON, Pf. 132

Wood based composites, too, are usually considered as combustible materials releasing toxic fumes when burning.

Inorganic building materials like stone, brick and concrete have high compression strength. One problem is that their tensile strength, and consequently, their bending strength, is very low. In the antiquity, this problem was handled by densely spaced columns, later by using arches. A serious breakthrough came with the invention of steel-reinforced concrete. In this structure, steel components resist tensile, flexural loads and shear, while concrete prevents compressive failure and buckling, and provides protection against corrosion.

While reinforced concrete is a “tried and true” material, one should note some disadvantages. Both steel and concrete have high density, thus their combination will be heavy as well. Also, the mineral resources of our world are not endless, and neither steel nor concrete are renewable materials. The possibility of creating new, lighter and more environment friendly load-bearing structures should be therefore investigated.

Engineered wood-based composite beams are relatively new products. Until recently, lightframe construction used solid wood only. Even though its development for commercial use started in 1967 (Kunesh 1978) it was not until the 80’s that LVL, the first engineered composite beam, entered the commercial market. LSL and PSL are even newer than that. The latter two composite types are true value-added products; they incorporate low-quality wood components – veneer strips and strands – to yield high-strength composite beam products (Wood Handbook 1999).

Inorganic bonded wood composites have been developed at the end of the 19th century (Kossatz et al. 1983, Winkler 1998). There are many different composite types, and their characteristics are much varied (Simatupang – Lange 1992). Even though their mechanical properties are typically low due to the lack of chemical bonds between the wood and the inorganic binder, they have several advantages. One is the superior fire resistance. Some high-density products have reached the A₂ fire-resistance class (non-flammable) according to DIN 4102 (Takats 1998). Inorganic bonded composite materials are typically produced as panel products or building blocks of various densities. There seems to be little indication in the literature that they have ever been considered as one-dimensional load-bearing elements (columns or beams).

Our research project is aimed at creating a composite beam from wood and cement. The goal is to produce beams that present a feasible compromise between the seemingly contradicting requirements of high strength, low weight, renewability and fire resistance. The technology and experience for producing inorganic-bonded wood composites, wood-based composite beams and concrete beams reinforced to resist tensile and flexural loads are already in place. In this project we attempt to combine these in a single product: the cement bonded wood composite beam.

The present article describes the first steps in the project. The objectives for this phase of the research were the following:

- manufacturing a limited number of beams of different structures and densities to verify that such products are feasible,
- comparing different types of wood constituents to establish what constituent geometry is better suited for such composites,
- determining the focus for the ongoing development of cement-bonded composite beams.

The weakest link in the fibre-matrix system is the interface between the cement matrix and the woody constituents. In wood-cement composite systems there is no chemical bond between the components. There is a physical connection between the wood and the cement mix. Fibre-cement interface testing is rarely done, because of technical difficulties in mounting the specimens on the test blocks.

Figure 1 shows the fracture surface of a cement bonded chipboard specimen. It confirms that the interface is indeed the weakest part of the system. Fracture occurs either in the matrix or at the interface. Even though this image was taken after a bending test, it is safe to assume that the same would happen in shear or internal bond tests. For this reason, our research did not include fibre-matrix interface testing.

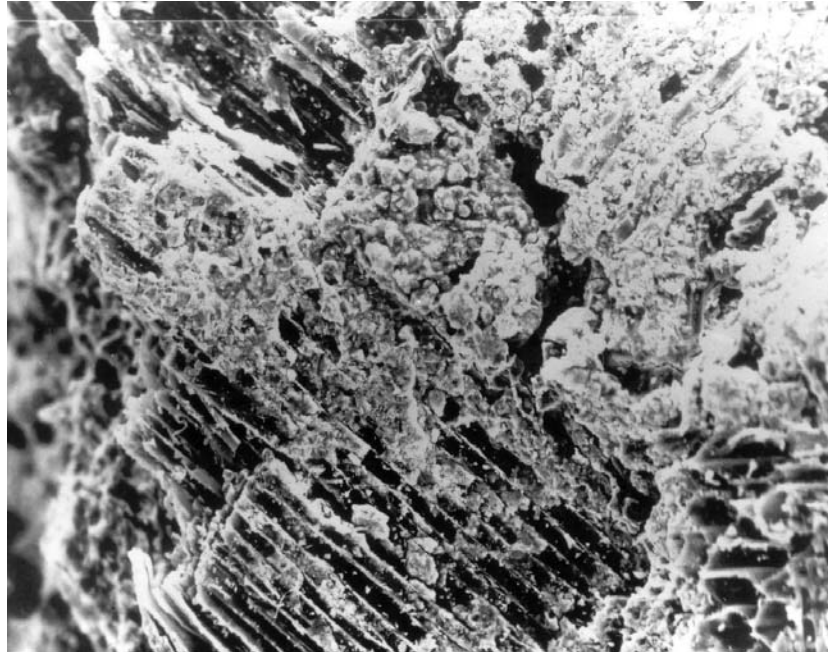

Figure 1. Scanning electromicroscopic image of the fibre-matrix interface (Takáts 2002)

2 MATERIALS AND METHODS

2.1 Composite beam manufacture

Experimentation included two basic composite beam structures: PSL type beams made of veneer strips and LSL type beams composed of strands. Both beam types were manufactured to two different target density values of 800 and 1100 kg/m³. For easier reference, the four beam types were named PSL800, PSL1100, LSL800 and LSL1100, respectively.

Raw material of the PSL type beams included 0.6 m long, 10mm wide and 3 mm thick poplar (*Populus x euramericana cv. I-214*) veneer strips. LSL type beams were made of standard Scots pine (*Pinus silvestris*) OSB face strands originating from KRONOSPAN Poland. Figure 2 demonstrates the shape and dimensions of the strands. We chose the above wood species because they, unlike many other species, do not contain chemical constituents that inhibit cement curing (Takáts 1998). We used high-strength Portland cement as a matrix material, with calciumchloride-dihydrate (CaCl₂ + H₂O) accelerator.

The mix was prepared using a 0.18 wood-cement ratio and a 0.4 water-cement ratio in all cases. Veneer and strand moisture content was estimated at 6%, according to the environment in which they had been kept for several weeks, and was accounted for when adding water. The amount of CaCl₂ additive was 3% of the amount of concrete, based on mass. The same mixture was used for the 800 and 1100 kg/m³ beams. The total of six beams produced included two pieces of both LSL800 and LSL1100, and one piece of both PSL800 and PSL1100.



Figure 2. OSB strands used for the LSL type beams

The six forming boxes were made of 30 mm thick MDF boards. Figure 3 shows the structure of the formwork. The height of the sidewalls was twice that of the beam, to house the forming web of the top piece designed to densify the material. According to the setup shown on Figure 3, final beam dimensions were 2 m x 0.1 m x 0.06 m.

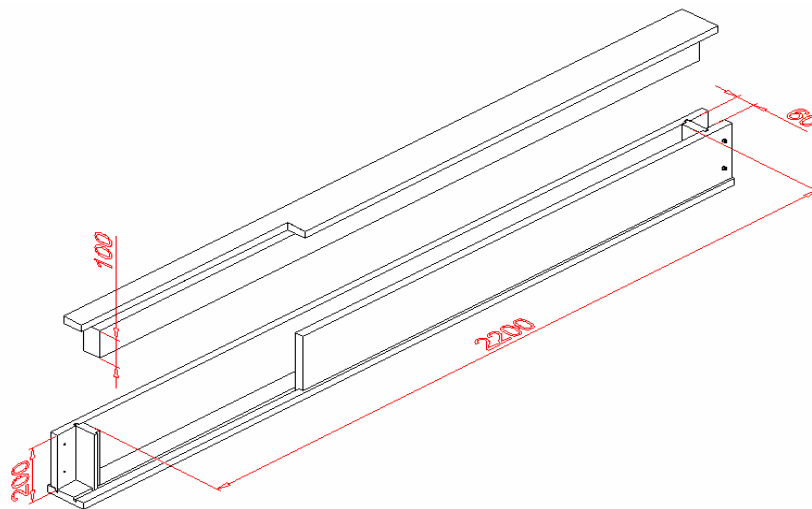

Figure 3. Formwork configuration and dimensions

Beam manufacture started by mixing strands and veneer strips with the required amount of water and CaCl_2 . This procedure allowed the wood components to take up most of the water necessary for cement cure, and gradually release it back into the matrix throughout the cure period. Unfortunately, thick veneer strips used for the PSL type product could not take up all of the water, which caused some of the hydrated cement to cluster, rather than covering the strips evenly, as happened in the case of LSL strands.

The next step was manually filling the mixture into the formwork. LSL strands were oriented using a funnel-like apparatus (Figure 4), while longer veneer strips aligned themselves well. Special care was taken to distribute the strands evenly along the length of the beam. For this reason, some veneer strips were broken to fill the ends of the PSL type beams. After filling the formwork, the mix was manually pre-pressed.



Figure 4. Aligning the strands in LSL type composites

The beams contained in their formworks were then placed into a standard single-daylight hot press. The press was closed and enough pressure applied so that the gap between the top and side pieces was closed completely. The press remained closed for the next 24 hours. Press platen heating was turned off during pressure application. After 24 hours the beams were removed from the hot press, and stored in an indoor environment ($T = 21^{\circ}\text{C}$, 50% R.H.) for a further 27 days.

2.2 Beam testing

Beam testing included non-destructive evaluation of the Young modulus using free longitudinal vibrations, and static bending tests. For non-destructive testing we used a measurement setup developed at the Non-destructive Testing Laboratory, UWH (Divos 2002). The basic principle of the test is the well-known fact that the stress-wave velocity of any material depends on the modulus of elasticity.

Figure 5 shows the test setup. Test pieces were supported at both ends. One end rested on a digital scale that measured the half-mass of the specimen. One end of the specimen was hit by a hammer, while a sensitive microphone picked up the vibration signal on the other end. Both the scale and the microphone were connected to a laptop computer that evaluated the data and – using the previously entered dimensional values – computed the stress-wave velocity, density and dynamic MOE. (Further details regarding stress-wave MOE determination may be found in Pellerin and Ross 2002.)

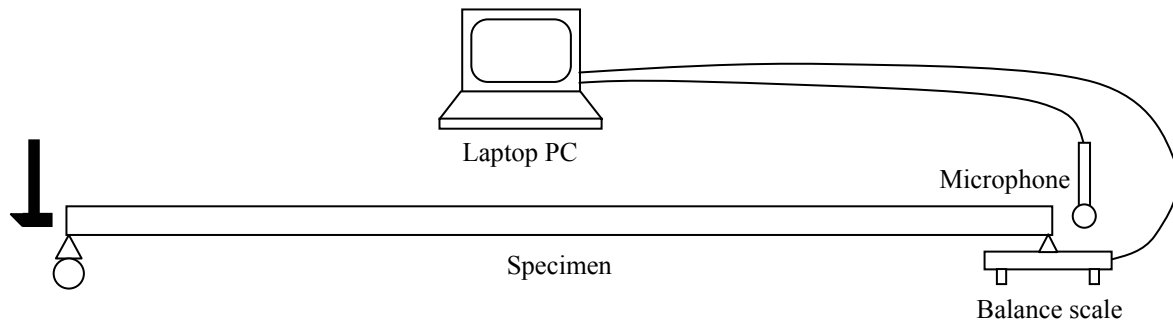

Figure 5. Dynamic MOE measurement setup

A 10 kN capacity Heckert FPZ 100/1 type universal screw-driven testing machine was used for the static bending tests. A three-point test setup was used for the measurements, with a crosshead speed of 5 mm/min that brought the beams to destruction in approximately sixty seconds. The testing machine recorded the load-deflection curves on paper. Deflection values were estimated by the cross-head displacement. The above practices were in accordance with an earlier Hungarian standard.¹

The cross-head penetrates into the material, as well as causing deflection, which decreases the measured MOE value. This penetration was fairly excessive in our case. Shear deformation that occurs when using the 3-point measurements also resulted in an underestimation of the MOE value. Because of the above, the MOE values reported in this article should be considered as apparent, approximate values only. MOR values, however, are accurate.

3 RESULTS AND DISCUSSION

Figure 6 shows the finished PSL and LSL type specimens. Cement clumping described in the previous section is clearly visible in the picture. Because of the larger cross section and higher stiffness of the veneer strips, the structure of the PSL type beams is less uniform, and contains more gaps. (This is true for organic-bonded PSL, too.) Table 1 summarises the measured density, static and dynamic mechanical properties of the beams.

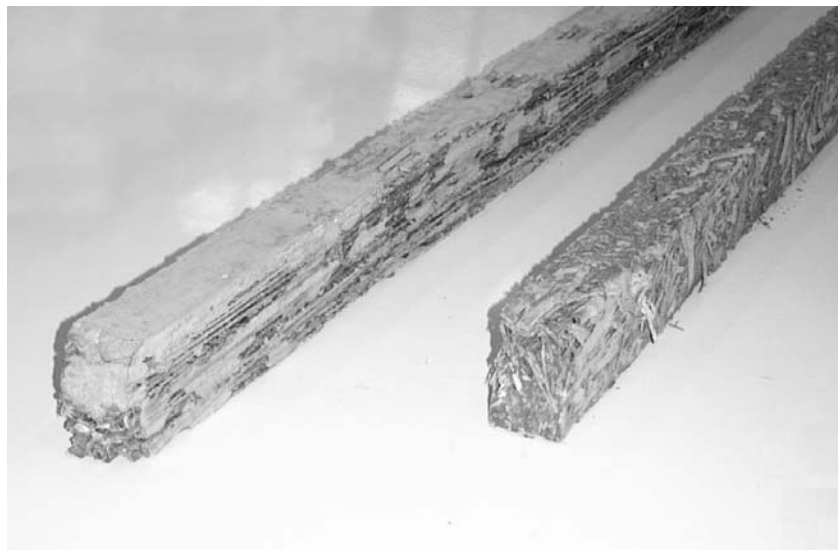

Figure 6. LSL (left) and PSL (right) cement bonded beams. Cement clumping is visible

¹ The European Standard EN 408:2003 describes the bending tests to be used for structural wood beams. Due to our limited means, our tests did not follow the specifications of this standard.

Table 1. Physical and mechanical properties of the beams

Beams	Density (kg/m ³)	MOR (MPa)	Static MOE (MPa)	Dynamic MOE (MPa)
LSL800 / 1	800	0.62	506	3 700
LSL800 / 2	780	1.34	1 123	1 150
LSL1100 / 1	1 140	5.74	2 699	5 600
LSL1100 / 2	1 100	3.44	2 218	5 500
PSL800	750	5.70	2 826	4 600
PSL1100	1 110	13.22	4 728	9 300

Lower density beams had consistently lower mechanical properties than those of the higher density ones. PSL performed better than LSL, but the values are still fairly low when compared to the strength and elastic properties of either solid wood or organic bonded composite beams (Table 2).

Table 2. Physical and mechanical properties of the raw material and of traditional composite beams

Wood species / composite beam type	Average density (kg/m ³)	MOR (MPa)	MOE (MPa)
Scots pine ¹	520	80	12 000
Poplar (clone 'I-214') ¹	320	58	5 330
Aspen LVL ²	566	62	8 960
Yellow-poplar PSL ²	673	73	13 800

¹ Source: Molnár and Bariska 2002

² Source: Bejo and Láng 2004

In most cases, dynamic MOE was roughly twice as high as the static value. This is partly due to the viscoelastic nature of the wood components, which makes the dynamically determined MOE roughly 10% higher than the static Young's modulus for solid wood (Divos – Tanaka 2000). The previously described inaccuracies, inherent to the measurement method, caused further discrepancies. In spite of these problems, the reasonably good correlation between dynamic and static MOE ($r^2 = 0.77$) gives some indication that vibration testing may be applicable to these composite beam types.

The superior strength of the PSL type beams is probably due to the length of the veneer strips. The length of the components is important, because, in cement bonded wood composites, there is no chemical bonding between the matrix and the fibre. Their integrity depends largely on the bonding surface. Long veneer strips are much harder to pull out of the matrix, than short strands. The longitudinal orientation of veneer strips was also much better than that of the shorter strand elements. Therefore, in spite of some manufacturing issues, like uneven cement distribution and structure, these beams proved to be much stronger than the LSL type beams.

The reason for the lower mechanical properties of the LSL type beams is mainly due to the short wood components that pulled out of the matrix relatively easily, and their alignment was less accurate than that of PSL veneer strips. There seems to be little room for improvement, therefore the concept of this beam type seems to be a cul-de-sac.

The positive correlation between beam density and mechanical properties was expected. Higher beam density was achieved through higher pressures during manufacture, which resulted in wood densification, elimination of gaps and improved connection between the matrix and the fibre. All of these contribute to the improved strength and stiffness.

3 SUMMARY AND CONCLUSIONS

Six experimental beams of various densities and composition were manufactured and tested for their mechanical properties, to assess the viability of cement-bonded composite beams for construction use. Of the two varieties, the PSL type beam performed better, and will be the basis of further product development. The load-bearing capacity of the composites was worse than that of solid wood. Further experimental work will be directed at improving the mechanical performance of the beams by solving some manufacturing issues that have been identified as problem areas. This will include:

- *Soaking veneer strips prior to mixing.* This way strips will contain the moisture needed for cement cure, and release it gradually into the matrix. This will prevent cement clumping and provide a more uniform structure.
- *Curing beams in a high humidity environment* would lead to better curing, as the moisture will be supplied by the atmosphere rather than the wood. This would decrease shrinkage that may sever the connection between the wood and the matrix during curing.
- *Using different wood component geometries*, namely, thinner and longer strips. These will take up water readily and resist being pulled out of the matrix.
- *Mixing strands and strips in the same product* might have advantages. The former can make the product stronger, while the latter fills in the gaps inherent to PSL geometry.

Acknowledgements: The authors express their thankfulness to Interspan Hungary and Heraklith Ltd. for their respective help in providing the strands and the cement needed for the experiments. Gratitude is also extended to Dr. Ferenc Divos at the Non-destructive Testing Laboratory and Szabolcs Csikos at the Institute of Applied Mechanics, UWH, for their help in beam testing. This research was partly funded by the Hungarian National Research and Development Programs (NKFP) research grant nr. 4/19/2001 (Forest-Wood Programme).

REFERENCES

- BEJO, L. – LÁNG, E.M. (2004): Simulation based modeling of the elastic properties of structural composite lumber. *Wood Fiber Sci.* 36 (3): 295-410.
- DIN 4102 Teil 1. 1981. Brandverhalten von Baustoffen und Bauteilen; Baustoffe; Begriffe, Anforderungen und Prüfungen. Beuth Verlag GmbH, Berlin. 15 p.
- DIVÓS, F. (2002): Portable lumber grader. In: Beall, F.C. (ed.): Proc. 13th Int. Symp. on Nondestructive Testing of Wood. Berkely, CA. August 19-21: 335.
- DIVÓS, F. – TANAKA, T. (2000): Effects of creep on modulus of elasticity determination of wood. *J. Vibration Acoustics - Transactions ASME* 122 (1): 89-92.
- EN 408:2003. Timber structures – Test methods – Solid timber and glued laminated timber – Determination of some physical and mechanical properties. CEN, Bruxelles, Belgium.
- FOREST PRODUCTS LABORATORY (1999): Wood handbook: wood as an engineering material. Washington DC: U.S. Department of Agriculture.

- KOSSATZ, G. – LEMPFER, K. – SATTLER, H. (1983): Anorganisch gebundene Holzwerkstoffplatten. Geschäftsbericht der Europäischen Föderation der Verbände der Spanplatten und anderer Werkstoffe. 98-108.
- KUNESH, R.H. (1978): MICRO = LAM: structural laminated veneer lumber. Forest Prod. J. 28(7): 41-44.
- MOLNÁR, S. – BARISKA, M. (2002). Magyarország ipari fái – Wood species of Hungary. Szaktudás Kiadó Ház, Budapest. 210 p. (bilingual)
- PELLERIN, R. F. – ROSS, R. J.: Transverse vibration and longitudinal stress wave nondestructive evaluation methods. In: Pellerin, R.F. – Ross, R.J. (eds.): Nondestructive evaluation of wood. Forest Products Society, Madison, WI. 13-37.
- SIMATUPANG, M.H. – LANGE, H. (1992): Herstellung und Anwendung mineralisch gebundener Holzwerkstoffe (1). Holz Zentralblatt 118 (20): 324-326.
- TAKÁTS, P. (1998). Szervetlen kötésű fa- és rost kompozitok. [Inorganic bonded wood and fibre composites]. Lecture Notes, University of Sopron. 109 p. (in Hungarian)
- WINKLER, A. (1998). Faforgácslapok [Chipboards]. Dinasztia Kiadó, Budapest. 183 p. (in Hungarian)

Guide for Authors

Submission of manuscripts

Acta Silvatica et Lignaria Hungarica publishes original reports and reviews in the field of forest, wood and environmental sciences. Submission of an article implies that the work has not been published previously (except in the form of an abstract or as part of a published lecture or academic thesis), and it is not under consideration for publication elsewhere. Articles should be written either in English or in German. All papers will be reviewed by two independent experts.

Authors of papers submitted for publication should sign the Publishing Agreement that can be downloaded from the homepage (<http://aslh.nyme.hu>).

For the first submission three hardcopies, for the final submission a single hardcopy of the paper should be sent by mail to the ASLH Editorial Office (University of West Hungary, Pf. 132, H-9401 Sopron, Hungary). The final manuscript should also be sent on a floppy or via e-mail (aslh@nyme.hu). The text should be formatted in MS Word.

Please also include all figures and tables as separate files in the form they were originally created in (e.g. MS Excel, Word, JPG). Save your files using the default extension of the program used.

Preparation of manuscripts

Manuscripts should be prepared on A4 International (210 by 297 mm) in single column format. Set the margins at 2.5 cm. Use 12 pitch Times New Roman as the font. The final layout of the text should be single-spaced (except for the first submission, before proofreading, when it should be double-spaced throughout, i.e. also for abstracts, footnotes and references). Every page of the manuscript should be numbered in the running head. However, in the text no reference should be made to page numbers. Keep the layout of the text as simple as possible. However, do use bold face, italics, subscripts, superscripts etc. but do not underline words. Do not embed 'graphically designed' equations or tables, but prepare these using the wordprocessor's facility.

Articles should not exceed 6000 words, including tables and references (and should not be longer than 16 pages including figures and graphs). They should be structured as follows (the parts in bold fonts are obligatory):

- **Title** (should be clear, descriptive and not too long, avoid unnecessary words like "data", "results", "experiments" etc.)
- **Name and affiliation of the author(s)**
- **E-mail and complete postal address of the corresponding author**
- **Abstract**
- **Keywords** (indexing terms), normally 3-6 items
- **Text with inserted figures/tables**
- Acknowledgements and any additional information concerning supporting grants, etc.
- **References**
- Appendices

To avoid unnecessary errors, authors are strongly advised to use the 'spellchecker' function of the wordprocessor. Use British English spelling throughout.

Authors whose native language is not English or German are strongly advised to have their papers checked by a native speaker before submitting it for publication.

Layout of final submission

Do not make a separate title page. Type the title of the paper after five empty lines from the top margin (18 pt, bold, centred) using party capital letters:

Title of the Original Paper

After *two empty lines* write the author's name (14 pt, centred). First name not abbreviated, family name in small capitals:

Adam FIRTAUTHOR^{a*} – Bill SECONDAUTHOR^a – Charles THIRDAUTHOR^b

After *one empty line* the affiliation, city and country of the authors (10 pt, centred):

^a Department of Specific Research, University of This and That, City, Country

^b Department of Specific Research, This and That Research Institute, City, Country

Mark the corresponding author with an * and give his/her e-mail and complete postal address in footnotes, 10 pt (* Corresponding author: account@domain.country; H-1118 BUDAPEST, Ménesi út 44.)

After *three empty lines* start the paper with an abstract.

Abstract

The paper should start with a short summary of the contents of the paper, not exceeding 160 words altogether. It is preferred that the abstract is in one single paragraph. It should give a clear idea of the main conclusions of the article, the methods employed and some indication of the line of reasoning. Use 11 pt characters. Heading (bold face) should be run within the text e.g.

Abstract – The paper reports on ...

Three to six **keywords** should be included (new paragraph, 6 pt before, 11 pitch bold characters). Keywords should not duplicate words in the title. The items should be separated by a slash (/) e.g.

forestry / wood / environment

After *two empty lines* the abstract and keywords should also be given in Hungarian language (for foreign authors the title and abstract will be translated by the editor) beginning with the translated title (bold face). Use 11 pitch characters e.g.

Kivonat – Cím fordítása magyarul. A tanulmány bemutatja.....

Text

It should be divided into sections, each with number and section heading. Use no more than three grades of headings. – Main sections e.g. Introduction; Material studied, area descriptions, methods, techniques; Results; Discussion; Conclusion. The heading titles should be short and clearly numbered. Titles and subtitles should be typed in a separate line, without indentation.

1 FIRST GRADE TITLES (12 pt bold capitals) should be preceded by two and followed by one empty line.

1.1 Second grade titles (12 pt bold) should be preceded by one empty line and followed by 6 pt.

1.1.1 Third grade titles (12 pt bold, italics) should be preceded by one empty line except when they are right after a second grade title.

Paragraphs should be justified, the first line of a new paragraph should be indented 0.75 cm. Do not separate paragraphs with one empty line or additional space.

Use italics for taxon names (*Quercus robur*) and for texts to be emphasized. Use single quotation marks ('odd use') for a specific use of an otherwise well-known term, and apply double quotation marks ("for citation") for citing text from other sources. Use italics for letter-abbreviated mathematical, statistical parameters quoted in the text (A , h^2)

Footnotes

Please do not use footnotes unless it is absolutely necessary. In most cases the information can be incorporated in the text. If the use of footnotes is inevitable, please use Arabic numerals.

Citations in the text

In the text refer to the author's name (without initial) and year of publication. Avoid excessive citation of sources. If quoting a specific passage insert a short reference to the appropriate page(s). If reference is made in the text to a publication written by more than two authors the name of the first author should be used followed by "et al." References cited together in the text should be arranged chronologically. When quoting in the text, place the references in parentheses in the following manner:

- *Single authors*: (Fekete 1999) or (Asimov 1984, p. 145)
- *Two authors*: (Schultz – Glasser 1986)
- *Three or more authors*: (Gugerli et al. 2001)
- *A list of authors*: (Hess 1952, Marton – Sparks 1967, Johnsson et al. 1998)
- *For multiple papers in the same year*: (Faraday 1977a,b)
- *Within a sentence*: Granier (1987) has stated ...
- *Quoting a specific passage*: „Empirical research confirms” (Smith 2003 pp. 23-24)

Tables

Authors should take notice of the limitation set by the size and layout of the journal. Tables spread across double pages are difficult to read and to arrange. If many data are to be presented, an attempt should be made to divide them over two or more tables. Reversing columns and rows will often reduce the dimension of a table. Avoid the parallel presentation of the same data both in figures and tables.

Tables should be numbered consecutively. The text should include references to all tables. The a reference should appear in italics (*Table 4*).

Each table should have a brief and self-explanatory title. The number and title of the tables should be printed in italics, before the table, left align.

Column headings should be brief, but sufficiently explanatory. Type table column headings with an initial capital only. Standard abbreviations of units of measurement should be added between parentheses. Vertical lines should not be used to separate columns.

Any explanation essential to the understanding of the table should be given as a footnote at the bottom of the table, in 10 pithc characters.

Table 1. A sample table (A single empty line before and followed by 6 pt)

Items	1950	1950 - 1986		1986	1986-2030		2030
		Increase	Decrease		Increase	Decrease	
Item 1	xxxx		xx	xxxx	xxx		xxxx
...							
Item n	xxx	xx		xxx		xxx	xx

Figures

When designing your figures, keep the size and the layout of the journal in mind. Colour figures are not yet supported in the printed version. The figures should be drawn to allow reduction to single column (7.5 cm) or double-column (15.5 cm) width. Use of very thin lines should therefore be avoided. Black and white illustrations, if also available in electronic format, are accepted.

Figures should be numbered according to their sequence in the text, and they should all have captions. The number and title of the figures should be printed in italics, below the figure, centred. Refer to all figures (*Figure 1*) in the text by using italics and initial capitals.

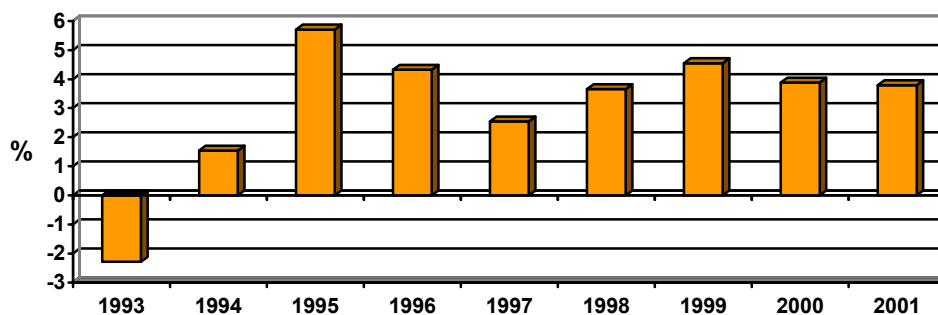

Figure 1. A sample figure

Formulae

- Avoid possible confusion between 0 (zero) and o, O (letters); 1 (one) and I (letter); ν (Greek nu) and u, v (letters), etc.
- Mathematical symbols should appear in italics, p , and matrices and vectors in boldface, \mathbf{a} , \mathbf{B} . Give the meaning of all symbols immediately after the equation in which they are first used.
- For simple fractions use the solidus (/) instead of a horizontal line.
- Equations and formulae should be centered and numbered serially at the right-hand side in parentheses if more than one is presented and quoted.

Acknowledgements

This paragraph should appear right before the References. The text should be as short as possible. Heading (bold face) should be run within the text e.g.

Acknowledgements: We wish to thank ...

References

The reference section should contain all works referred to in the text, and only those. They should be listed fully in alphabetical order of the author/editor with complete bibliographical details (including publisher and place of publication). The list of references should be

arranged chronologically per author. If an author's name in the list is also mentioned with co-authors, the following order should be used: publications of the single author, arranged according to publication dates, publications of the same author with one co-author, publications of the author with more than one co-author. Publications of the same author(s) in the same year should be listed as 1996a, 1996b, etc. The manuscript should be carefully checked to ensure that the spelling of author's names and dates are exactly the same in the text as in the reference list.

Use 11 pitch characters and 0.75 cm indentation from the second row on in a paragraph. Write the family name of the authors with small capitals and only the initials of the first names. Put a comma (,) after the family name and use dashes (–) when there are two or more authors. Write the year of the issue in parenthesis behind the authors' names and then use colon (:)

Note:

- Page references must be given for chapters in books and papers in journals.
- No italics except for taxa (*Corvus corax*) are used in the reference list.
- Use full name of less widely known journals (Applied Forestry), and abbreviate known journals (J. Ecol.).
- Where possible avoid the use of ANON. and ANONYMOUS in the list of references. Instead, use the publisher's name.
- In the case of publications in any language other than English or German, the original title should be retained, and the [translated title] should be given in cornered parenthesis. A notation such as "(in Swedish)" or "(in Hungarian with English abstract)" should be added following the complete bibliographical details. However, the titles of publications in non-Roman alphabets (Russian, Japanese) should be transliterated. Transliteration should follow English rules (e.g. xopomo = kharasho)

Reference should conform to the following examples:

For books:

AUTHOR, A. (1995): Book title. Publishing company, City. xx p.

CODY, M. L. (1974): Competition and the structure of bird communities. Series: Monographs in Population Biology. Princeton Univ. Press. Princeton. 326 p.

For an article/chapter in a book

AUTHOR, D. (1984): Title of the article. In: Firsteditor, U. – Secondeditor V. (eds.): Title of the book. Publishing company, City. x-xx.

TOPPINEN, A. – ADAMS, D. – MONTGOMERY, D. (2001): Biodiversity conservation and forest products in the United States Pacific Northwest. In: Palo, M. – Uusivuori, J. – Mery, G. (eds.): World forests, Markets and Policies. Kluwer Academic Publishers, Dordrecht. 385-394.

For journal articles:

AUTHOR, B.C. (1977): Title of the paper. Journal Vol. (No): x-xx.

GRAY, A.N. – SPIES, T.A. (1997): Microsite controls on tree seedling establishment in conifer forest canopy gaps. Ecology 78 (8): 2458-2473.

When the author is unknown:

PUBLISHER (2003): Name of the publication. x-xx.

FAO (1993): Tropical Forest Resource Assessment 1990. Forestry paper No. 112. FAO, Rome, Italy.

For work accepted for publication but not yet published:

AUTHOR, E. (in press): Title of the paper. Journal.

For publication in other languages:

SOLYMOS, R. (2005): Erdő-és fagazdaságunk időszerű kérdései. [Contemporary questions of forestry and wood industry.] MTA, Budapest. 411 p. (in Hungarian)

For conference proceedings

BEALL, F.C. (ed.) (2002): Proceedings of the 13th International Symposium on Nondestructive Testing of Wood. Berkeley, CA. 335 p.

For a paper in conference proceedings

PAIN, O. – BOYER, E. (1996): A whole individual tree growth model for Norway spruce. In: Proceedings of the second Workshop “Connection between Silviculture and Wood Quality through Modelling Approaches and Simulation Software”. South Africa. August 1996. 13-23.

For Internet sites:

AUTHOR (Date): Title of Web Page. Publisher with town and country, URL.

Inclusion of publisher with town and country makes the citation more durable, because finding the reference does not depend entirely on the URL remaining correct.

FAO (2001): Forest resource assesment 2000. FAO, Rome, Italy. Online:
<http://www.fao.org/forestry/fo/fra>.

Reprints

The editorial board provides 20 reprints for the corresponding author.

